

TIP	PRODUS	PAG	TIP	PRODUS	PAG
	R1A R2A	2	ORFS	male female	21
	R1AT R2AT	3	ORFS	90 female 45 female	22
	R1AT - R2AT R1AT - R2AT NEW	4	DKOL	Metric male 24 cone I.T. Serie L	23
	R9R 4SH	5	DKOL	O'ring metric female 24 cone 24 I.T.	24
	R7	6	DKOL	90 O'ring metric swept elbow cone 24 I.T.	25
BSP	male parallel 60	7	DKOL	45 O'ring metric swept elbow cone 24 I.T.	26
BSP	straight female 60	8	DKOL	Metric male 24 cone H.T.	27
BSP	female 90 swept elbow	9	DKOS	O'ring metric female 24 cone 24 H.T.	28
BSP	female 45 swept elbow	10	DKOS	C90 90 O'ring metric swept elbow cone 24 H.T.	29
BSP	O'ring female thrust wired nut C90 O'ring female thrust wired nut	11	DKOS	C45 90 O'ring metric swept elbow cone 24 H.T.	30
BSP	C45 O'ring female thrust wired nut parallel flat seat male	12	CONEXIUNI	Straight standpipe	31
BSP	flat seat female female free nut	13	CONEXIUNI	Double connector	32
BSP	C90 Female free nut C45 Female free nut	14	BANJO	BSP banjo	32
BSP	C90 compact female 90 swept elbow	15	BANJO	Metric banjo	33
NPTF	male 60	15	FLANGE	SAE 3000 PSI 90 FLANGE SAE 3000 PSI	34
JIC	male SV 74	16	FLANGE	45 FLANGE SAE 3000 PSI FLANGE SAE 6000 PSI	35
JIC	female SV 74	17	FLANGE	90 FLANGE SAE 6000 PSI 45 FLANGE SAE 6000 PSI	36
JIC	C90 female swept elbow 74 cone seat	18	FLANGE	SUPERCAT SUPERCAT 90	37
JIC	C45 Female swept elbow 74 cone seat	19	FLANGE	SUPERCAT 45	38
JIS	Metric female 60 female 60	20	FLANGE	Split flange clamps couple SAE 3000 Split flange clamps couple SAE 6000	39

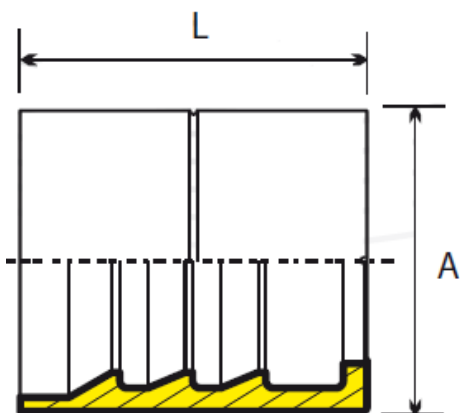

Ferrule R1A



COD	FURTUN			FILET F	DIMENSIUNI (MM)			
	DN	INCH	DIAM		CH	B	A	L
121100.03	5	3/16	03				17	26.4
121100.04	6	1/4	04				20	29.5
121100.05	8	5/16	05				22	29.6
121100.06	10	3/8	06				24	32.0
121100.08	12	1/2	08				29	34.3
121100.10	16	5/8	10				32	37.2
121100.12	20	3/4	12				36	43.2
121100.16	25	1	16				43	50.6
121100.20	32	1.1/4	20				52	56.7
121100.24	40	1.1/2	24				57	63.0
121100.32	50	2	32				70	78.0

Ferrule R2A

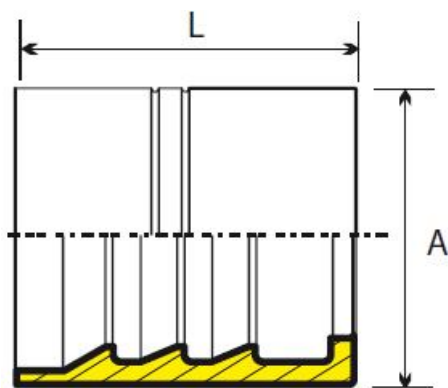

COD	FURTUN			FILET F	DIMENSIUNI (MM)			
	DN	INCH	DIAM		CH	B	A	L
121204.03	5	3/16	03				20	27.1
121204.04	6	1/4	04				21	30.4
121204.05	8	5/16	05				24	30.3
121204.06	10	3/8	06				26	32.4
121204.08	12	1/2	08				30	34.0
121204.10	16	5/8	10				34	37.5
121204.12	20	3/4	12				38	43.2
121204.16	25	1	16				46	50.0
121204.20	32	1.1/4	20				56	59.0
121204.24	40	1.1/2	24				63	63.0
121204.32	50	2	32				75	78.9





Ferrule R1AT

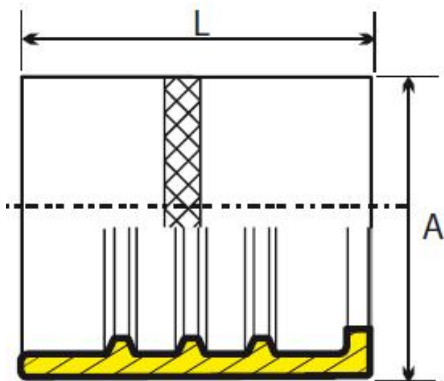

COD	FURTUN			FILET	DIMENSIUNI (MM)			
	DN	INCH	DIAM	F	CH	B	A	L
121050.03	5	3/16	03				19.0	26.0
121050.04	6	1/4	04				20.0	30.5
121050.05	8	5/16	05				22.0	30.5
121050.06	10	3/8	06				24.0	34.0
121050.08	12	1/2	08				29.0	37.0
121050.10	16	5/8	10				32.0	36.0
121050.12	20	3/4	12				42.5	50.5
121050.16	25	1	16				43.0	36.0
121050.20	32	1.1/4	20				53.0	36.0
121050.24	40	1.1/2	24				60.0	36.0

Ferrule R2AT

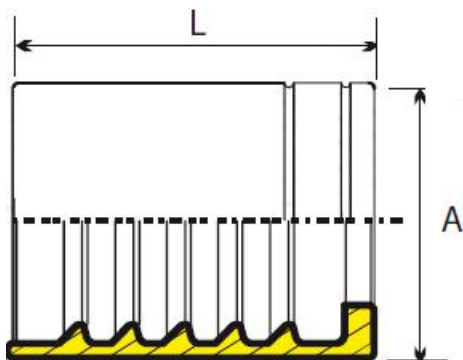

COD	FURTUN			FILET	DIMENSIUNI (MM)			
	DN	INCH	DIAM	F	CH	B	A	L
121200.03	5	3/16	03				19.0	26.0
121200.04	6	1/4	04				20.0	30.5
121200.05	8	5/16	05				22.0	30.5
121200.06	10	3/8	06				24.0	34.0
-	-	-	-				-	-
-	-	-	-				-	-
-	-	-	-				-	-
121200.16	25	1	16				43.0	36.0
121200.20	32	1.1/4	20				53.0	36.0
121200.24	40	1.1/2	24				60.0	36.0





Ferrule R1AT - R2AT

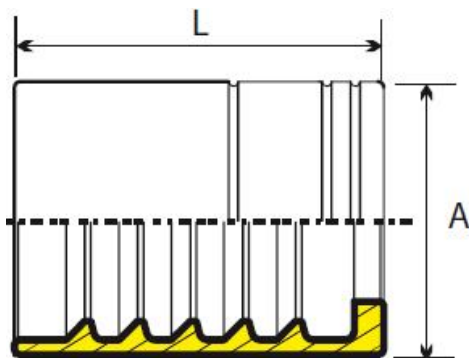

COD	FURTUN			FILET F	DIMENSIUNI (MM)			
	DN	INCH	DIAM		CH	B	A	L
-	-	-	-				-	-
-	-	-	-				-	-
-	-	-	-				-	-
121200.08	12	1/2	08				29	35.0
121200.10	16	5/8	10				32	37.5
121200.12	20	3/4	12				36	42.5
-	-	-	-				-	-
-	-	-	-				-	-
-	-	-	-				-	-

Ferrule R1AT - R2AT NEW

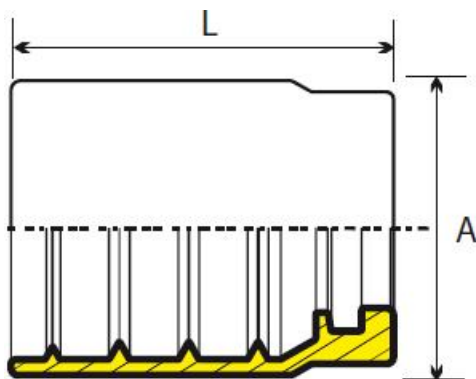

COD	FURTUN			FILET F	DIMENSIUNI (MM)			
	DN	INCH	DIAM		CH	B	A	L
121300.03	5	3/16	03				21	23
121300.04	6	1/4	04				23	30
121300.05	8	5/16	05				24	30
121300.06	10	3/8	06				26	32
121300.08	12	1/2	08				29	34
121300.10	16	5/8	10				33	37
121300.12	20	3/4	12				37	42
121300.16	25	1	16				46	51
121300.20	32	1.1/4	20				59	59
121300.24	40	1.1/2	24				67	67
121300.32	50	2	32				80	72





Ferrule R9R

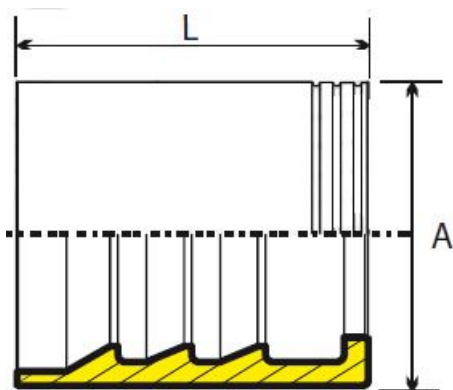

COD	FURTUN			FILET	DIMENSIUNI (MM)			
	DN	INCH	DIAM	F	CH	B	A	L
-	-	-	-				-	-
122001.04	6	1/4	04				21	30.5
-	-	-	-				-	-
122001.06	10	3/8	06				26	32.0
122001.08	12	1/2	08				30	34.0
122001.10	16	5/8	10				34	40.0
122001.12	20	3/4	12				38	51.5
122001.16	25	1	16				46	60.0
122001.20	32	1.1/4	20				56	66.0
122001.24	40	1.1/2	24				65	76.5
122001.32	50	2	32				80	80.0

Ferrule 4SH

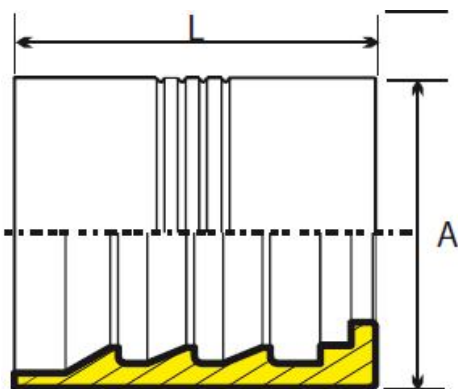

COD	FURTUN			FILET	DIMENSIUNI (MM)			
	DN	INCH	DIAM	F	CH	B	A	L
-	-	-	-				-	-
-	-	-	-				-	-
-	-	-	-				-	-
-	-	-	-				-	-
-	-	-	-				-	-
-	-	-	-				-	-
-	-	-	-				-	-
-	-	-	-				-	-
122500.20	32	1.1/4	20				52	66.0
122500.24	40	1.1/2	24				62	76.5
122500.32	50	2	32				75	80.0





Ferrule R7

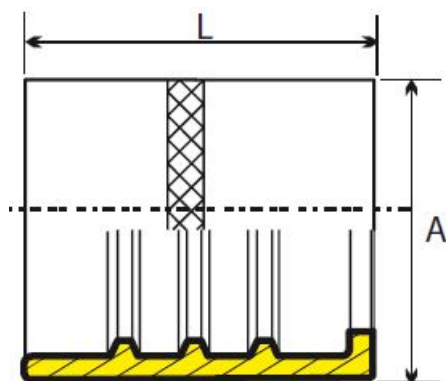

COD	FURTUN			FILET	DIMENSIUNI (MM)			
	DN	INCH	DIAM	F	CH	B	A	L
123200.03	5	3/16	03				14.0	30.0
123200.04	6	1/4	04				17.0	30.2
123200.05	8	5/16	05				19.0	29.8
123200.06	10	3/8	06				21.0	30.4
123200.08	12	1/2	08				25.5	34.2
123200.10	16	5/8	10				28.5	36.3
123200.12	20	3/4	12				32.1	42.4
123200.16	25	1	16				40.0	50.2
-	-	-	-				-	-
-	-	-	-				-	-





BSP male parallel 60°

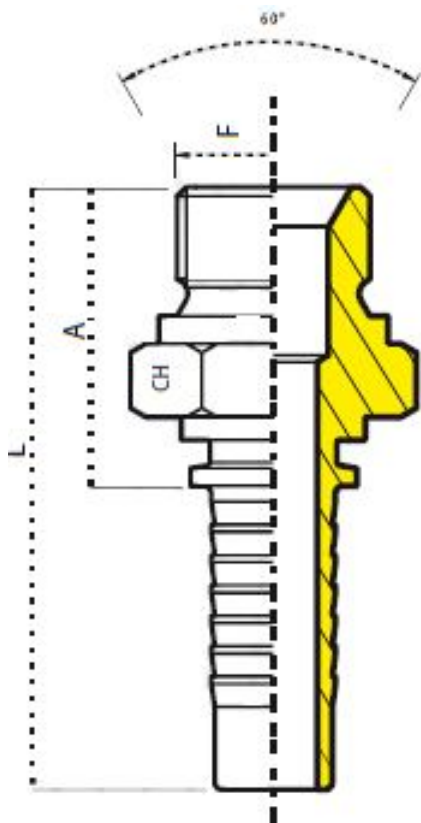

COD	FURTUN			FILET	DIMENSIUNI (MM)			
	DN	INCH	DIAM		CH	B	A	L
160101.0302	5	3/16	03	1/8"-28	15	-	21	45
160101.0304	5	3/16	03	1/4"-19	19	-	26	51
160101.0402	6	1/4	04	1/8"-28	15	-	21	49
160101.0404	6	1/4	04	1/4"-19	19	-	27	55
160101.0406	6	1/4	04	3/8"-19	22	-	29	57
160101.0408	6	1/4	04	1/2"-14	27	-	32	60
160101.0504	8	5/16	05	1/4"-19	19	-	27	55
160101.0506	8	5/16	05	3/8"-19	22	-	29	57
160101.0508	8	5/16	05	1/2"-14	27	-	32	60
160101.0604	10	3/8	06	1/4"-19	19	-	27	57
160101.0606	10	3/8	06	3/8"-19	22	-	29	59
160101.0608	10	3/8	06	1/2"-14	27	-	32	62
160101.0806	12	1/2	08	3/8"-19	19	-	29	62
160101.0808	12	1/2	08	1/2"-14	27	-	33	66
160101.0810	12	1/2	08	5/8"-14	28	-	35	68
160101.0812	12	1/2	08	3/4"-14	32	-	36	69
160101.1008	16	5/8	10	1/2"-14	27	-	33	69
160101.1010	16	5/8	10	5/8"-14	28	-	35	71
160101.1012	16	5/8	10	3/4"-14	32	-	36	72
160101.1208	20	3/4	12	1/2"-14	27	-	34	75
160101.1210	20	3/4	12	5/8"-14	28	-	36	77
160101.1212	20	3/4	12	3/4"-14	32	-	37	7
160101.1216	20	3/4	12	1"-11	38	-	40	80
160101.1612	25	1	16	3/4"-14	32	-	38	93
160101.1616	25	1	16	1"-11	38	-	40	95
160101.1620	25	1	16	1.1/4"-11	50	-	45	100
160101.2020	32	1.1/4	20	1.1/4"-11	50	-	46	106
160101.2024	32	1.1/4	20	1.1/2"-11	55	-	46	107
160101.2424	40	1.1/2	24	1.1/2"-11	55	-	46	117
160101.2432	40	1.1/2	24	2"-11	70	-	53	124
160101.3232	50	2	32	2"-11	70	-	54	134



BSP straight female 60°

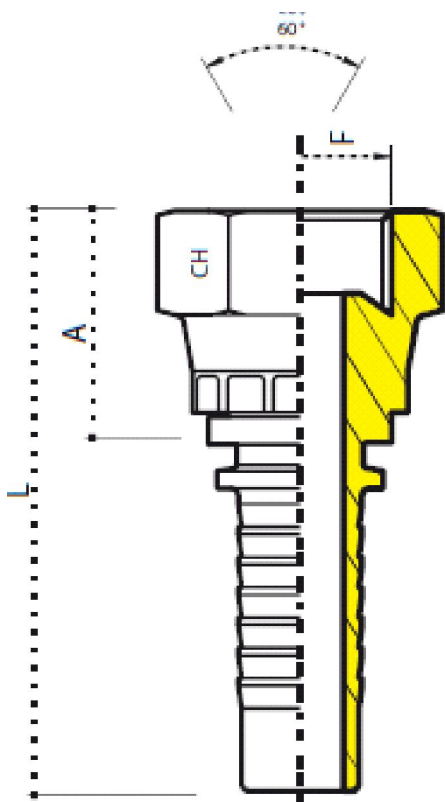

COD	FURTUN			FILET	DIMENSIUNI (MM)			
	DN	INCH	DIAM	F	CH	B	A	L
140100.0302	5	3/16	03	1/8"-28	15	-	18	43
140100.0304	5	3/16	03	1/4"-19	19	-	18	43
140100.0402	6	1/4	04	1/8"-28	15	-	18	46
140100.0404	6	1/4	04	1/4"-19	19	-	18	46
140100.0406	6	1/4	04	3/8"-19	22	-	19	47
140100.0408	6	1/4	04	1/2"-14	27	-	21	49
140100.0504	8	5/16	05	1/4"-19	19	-	18	46
140100.0506	8	5/16	05	3/8"-19	22	-	19	47
140100.0508	8	5/16	05	1/2"-14	27	-	21	49
140100.0604	10	3/8	06	1/4"-19	19	-	19	49
140100.0606	10	3/8	06	3/8"-19	22	-	20	50
140100.0608	10	3/8	06	1/2"-14	27	-	21	51
140100.0806	12	1/2	08	3/8"-19	19	-	20	53
140100.0808	12	1/2	08	1/2"-14	27	-	22	55
140100.0810	12	1/2	08	5/8"-14	28	-	22	55
140100.0812	12	1/2	08	3/4"-14	32	-	24	57
140100.1008	16	5/8	10	1/2"-14	27	-	22	58
140100.1010	16	5/8	10	5/8"-14	28	-	23	59
140100.1012	16	5/8	10	3/4"-14	32	-	24	60
140100.1208	20	3/4	12	1/2"-14	-	-	-	-
140100.1210	20	3/4	12	5/8"-14	32	-	24	66
140100.1212	20	3/4	12	3/4"-14	32	-	25	66
140100.1216	20	3/4	12	1"-11	38	-	26	67
140100.1612	25	1	16	3/4"-14	-	-	-	-
140100.1616	25	1	16	1"-11	38	-	27	82
140100.1620	25	1	16	1.1/4"-11	50	-	30	85
140100.2020	32	1.1/4	20	1.1/4"-11	50	-	30	91
140100.2024	32	1.1/4	20	1.1/2"-11	55	-	32	93
140100.2424	40	1.1/2	24	1.1/2"-11	55	-	32	103



BSP female 90° swept elbow

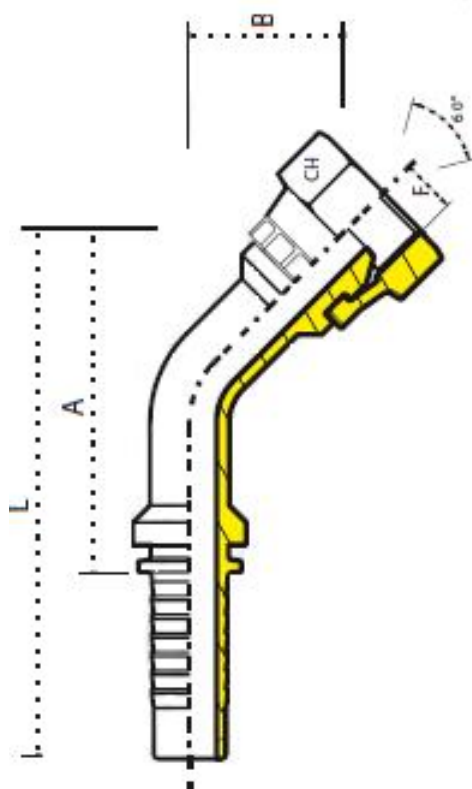

COD	FURTUN			FILET	DIMENSIUNI (MM)			
	DN	INCH	DIAM	F	CH	B	A	L
180102.0302	5	3/16	03	1/8"-28	15	29	23	47.5
180102.0304	5	3/16	03	1/4"-19	19	29	23	47.5
180102.0402	6	1/4	04	1/8"-28	15	29	23	51
180102.0404	6	1/4	04	1/4"-19	19	29	23	51
180102.0406	6	1/4	04	3/8"-19	22	32	23	51
180102.0408	6	1/4	04	1/2"-14	-	-	-	-
180102.0504	8	5/16	05	1/4"-19	19	33.5	31.5	59.5
180102.0506	8	5/16	05	3/8"-19	22	33.5	31.5	59.5
180102.0508	8	5/16	05	1/2"-14	27	39	31.5	59.5
180102.0604	10	3/8	06	1/4"-19	19	37	33	63
180102.0606	10	3/8	06	3/8"-19	22	38	33	63
180102.0608	10	3/8	06	1/2"-14	27	42	33	63
180102.0806	12	1/2	08	3/8"-19	22	43	39	72
180102.0808	12	1/2	08	1/2"-14	27	45	39	72
180102.0810	12	1/2	08	5/8"-14	28	45	39	72
180102.0812	12	1/2	08	3/4"-14	32	51	39	72
180102.1008	16	5/8	10	1/2"-14	27	54	49	85
180102.1010	16	5/8	10	5/8"-14	28	54	49	85
180102.1012	16	5/8	10	3/4"-14	32	56	49	85
180102.1208	20	3/4	12	1/2"-14	-	-	-	-
180102.1210	20	3/4	12	5/8"-14	-	-	-	-
180102.1212	20	3/4	12	3/4"-14	32	59	53.5	94.5
180102.1216	20	3/4	12	1"-11	38	65	53.5	94.5
180102.1612	25	1	16	3/4"-14	-	-	-	-
180102.1616	25	1	16	1"-11	38	72	73	128
180102.1620	25	1	16	1.1/4"-11	50	80	73	128
180102.2020	32	1.1/4	20	1.1/4"-11	50	93	89	150
180102.2024	32	1.1/4	20	1.1/2"-11	55	98.5	89	150
180102.2424	40	1.1/2	24	1.1/2"-11	55	114	101	172



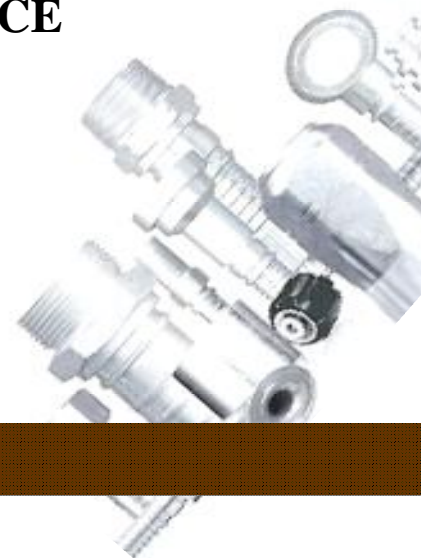

BSP female 45° swept elbow

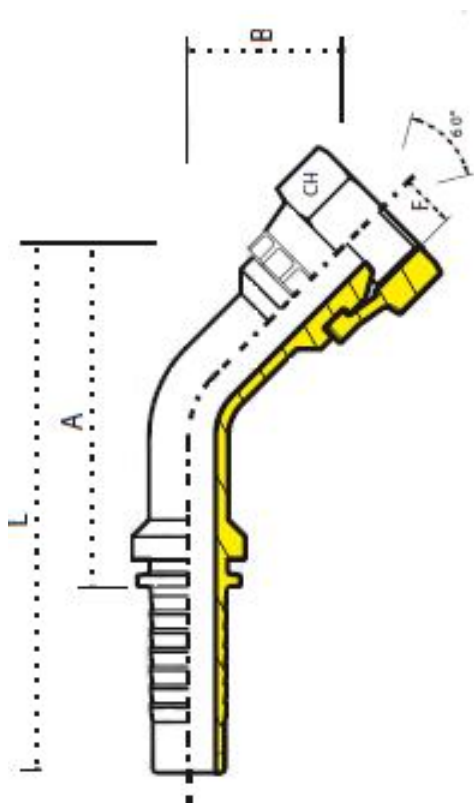

COD	FURTUN			FILET	DIMENSIUNI (MM)			
	DN	INCH	DIAM	F	CH	B	A	L
200103.0302	5	3/16	03	1/8"-28	15	17	40	65
200103.0304	5	3/16	03	1/4"-19	19	17	40	65
200103.0402	6	1/4	04	1/8"-28	15	17	40	68
200103.0404	6	1/4	04	1/4"-19	19	17	40	68
200103.0406	6	1/4	04	3/8"-19	22	20	43	71
200103.0408	6	1/4	04	1/2"-14	-	-	-	-
200103.0504	8	5/16	05	1/4"-19	19	20	51	79
200103.0506	8	5/16	05	3/8"-19	22	21	52	80
200103.0508	8	5/16	05	1/2"-14	27	24	55	83
200103.0604	10	3/8	06	1/4"-19	19	19	54	84
200103.0606	10	3/8	06	3/8"-19	22	20	55	85
200103.0608	10	3/8	06	1/2"-14	27	23	58	88
200103.0806	12	1/2	08	3/8"-19	22	20	63	96
200103.0808	12	1/2	08	1/2"-14	27	23	65	98
200103.0810	12	1/2	08	5/8"-14	28	23	65	98
200103.0812	12	1/2	08	3/4"-14	32	21	66	99
200103.1008	16	5/8	10	1/2"-14	27	25	63	99
200103.1010	16	5/8	10	5/8"-14	28	25	64	99
200103.1012	16	5/8	10	3/4"-14	32	26	64	100
200103.1208	20	3/4	12	1/2"-14	27	28	62	103
200103.1210	20	3/4	12	5/8"-14	28	29	63	104
200103.1212	20	3/4	12	3/4"-14	32	29	63	104
200103.1216	20	3/4	12	1"-11	38	31	65	105
200103.1612	25	1	16	3/4"-14	32	39	88	143
200103.1616	25	1	16	1"-11	38	41	90	145
200103.1620	25	1	16	1.1/4"-11	50	44	93	148
200103.2020	32	1.1/4	20	1.1/4"-11	50	44	102	163
200103.2024	32	1.1/4	20	1.1/2"-11	55	45	103	164
200103.2424	40	1.1/2	24	1.1/2"-11	55	45	118	189



BSP O'ring female thrust wired nut

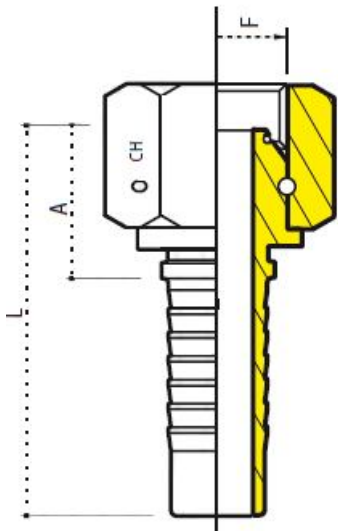

COD	FURTUN			FILET	DIMENSIUNI (MM)			
	DN	INCH	DIAM	F	CH	B	A	L
140100.1212F	20	3/4	12	3/4"-14	32	-	25	66
140100.1216F	20	3/4	12	1"-11	38	-	25	67
140100.1616F	25	1	16	1"-11	38	-	27	82
140100.1620F	25	1	16	1.1/4"-11	50	-	30	85
140100.2020F	32	1.1/4	20	1.1/4"-11	50	-	30	91
140100.2024F	32	1.1/4	20	1.1/2"-11	55	-	32	93
140100.2424F	40	1.1/2	24	1.1/2"-11	55	-	32	103
140100.2432F	40	1.1/2	24	2"-11	70	-	33	104
140100.3232F	50	2	32	2"-11	70	-	34	114

BSP C90 O'ring female thrust wired nut

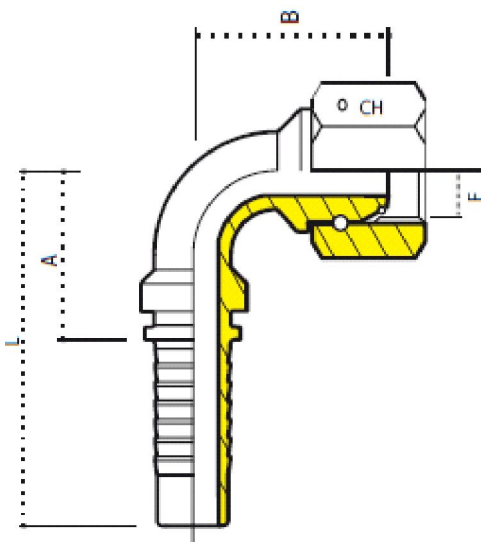

COD	FURTUN			FILET	DIMENSIUNI (MM)			
	DN	INCH	DIAM	F	CH	B	A	L
180102.1212F	20	3/4	12	3/4"-14	32	59.0	53.0	94.0
180102.1216F	20	3/4	12	1"-11	38	65.0	53.5	94.5
180102.1616F	25	1	16	1"-11	38	72.0	73.0	128.0
180102.1620F	25	1	16	1.1/4"-11	50	80.0	73.0	128.0
180102.2020F	32	1.1/4	20	1.1/4"-11	50	93.0	89.0	150.0
180102.2024F	32	1.1/4	20	1.1/2"-11	55	98.5	89.0	150.0
180102.2424F	40	1.1/2	24	1.1/2"-11	55	114.0	101.0	172.0
180102.2432F	40	1.1/2	24	2"-11	70	118.0	101.0	172.0
180102.3232F	50	2	32	2"-11	70	136.0	135.0	215.0



BSP C45 O'ring female thrust wired nut

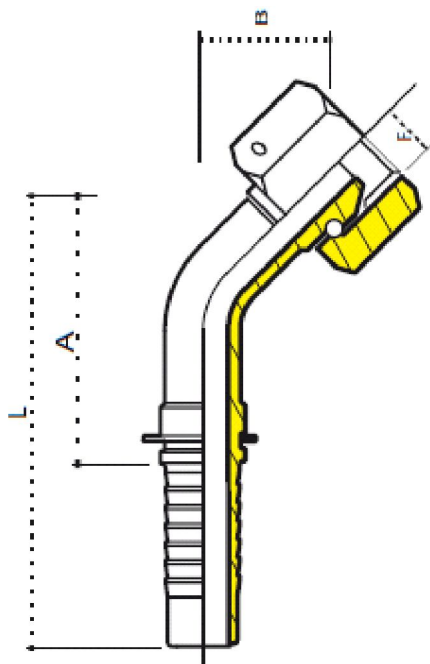

COD	FURTUN			FILET	DIMENSIUNI (MM)			
	DN	INCH	DIAM	F	CH	B	A	L
200103.1212F	20	3/4	12	3/4"-14	32	29	63	104
200103.1216F	20	3/4	12	1"-11	38	31	65	105
200103.1616F	25	1	16	1"-11	38	41	90	145
200103.1620F	25	1	16	1.1/4"-11	50	44	93	148
200103.2020F	32	1.1/4	20	1.1/4"-11	50	44	102	163
200103.2024F	32	1.1/4	20	1.1/2"-11	55	45	103	164
200103.2424F	40	1.1/2	24	1.1/2"-11	55	45	118	189
200103.2432F	40	1.1/2	24	2"-11	70	48	121	192
200103.3232F	50	2	32	2"-11	70	68	156	236

BSP parallel flat seat male

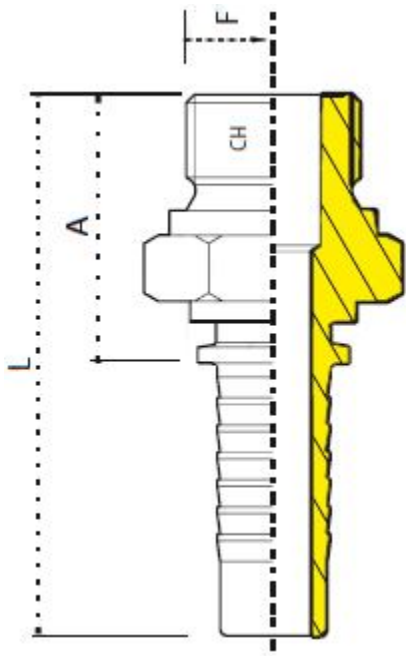

COD	FURTUN			FILET	DIMENSIUNI (MM)			
	DN	INCH	DIAM	F	CH	B	A	L
160550.0404	6	1/4	04	1/4"-19	19	-	27.0	55.0
160550.0406	6	1/4	04	3/8"-19	22	-	29.0	57.0
160550.0506	8	5/16	05	3/8"-19	22	-	29.0	57.0
160550.0606	10	3/8	06	3/8"-19	22	-	28.5	58.5
160550.0608	10	3/8	06	1/2"-14	27	-	32.0	62.0
160550.0808	12	1/2	08	1/2"-14	27	-	32.0	65.0
160550.0810	12	1/2	08	5/8"-14	28	-	35.0	68.0
160550.0812	12	1/2	08	3/4"-14	32	-	36.0	69.0
160550.1010	16	5/8	10	5/8"-14	28	-	35.0	71.0
160550.1012	16	5/8	10	3/4"-14	32	-	36.0	72.0
160550.1212	20	3/4	12	3/4"-14	32	-	37.0	78.0
160550.1216	20	3/4	12	1"-11	38	-	40.0	80.0
160550.1616	25	1	16	1"-11	38	-	39.5	94.5
160550.2020	32	1.1/4	20	1.1/4"-11	50	-	46.0	106.0



BSP flat seat female

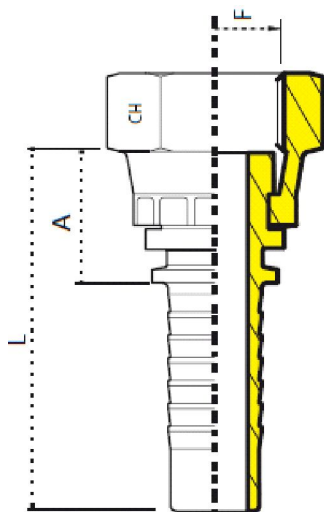

COD	FURTUN			FILET	DIMENSIUNI (MM)			
	DN	INCH	DIAM	F	CH	B	A	L
140300.0404	6	1/4	04	1/4"-19	19	-	14	42
140300.0406	6	1/4	04	3/8"-19	22	-	15	43
140300.0506	8	5/16	05	3/8"-19	22	-	15	43
140300.0606	10	3/8	06	3/8"-19	22	-	16	46
140300.0608	10	3/8	06	1/2"-14	27	-	17	47
140300.0808	12	1/2	08	1/2"-14	27	-	17	50
140300.0810	12	1/2	08	5/8"-14	28	-	17	50
140300.0812	12	1/2	08	3/4"-14	32	-	19	52
140300.1010	16	5/8	10	5/8"-14	28	-	17	53
140300.1012	16	5/8	10	3/4"-14	32	-	20	56
140300.1212	20	3/4	12	3/4"-14	32	-	21	62
140300.1216	20	3/4	12	1"-11	38	-	22	63
140300.1616	25	1	16	1"-11	38	-	23	78
140300.2020	32	1.1/4	20	1.1/4"-11	50	-	26	87

BSP female free nut

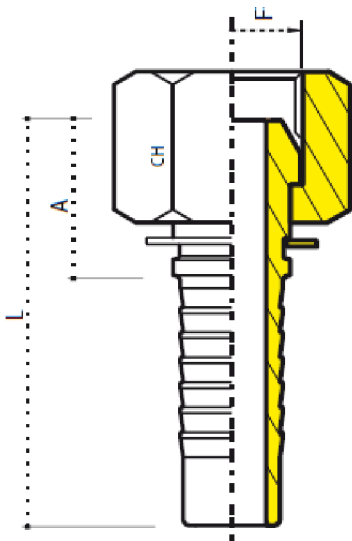

COD	FURTUN			FILET	DIMENSIUNI (MM)			
	DN	INCH	DIAM	F	CH	B	A	L
140100.0302PS	5	3/16	03	1/8"-28	15	-	18	43
140100.0304PS	5	3/16	03	1/4"-19	19	-	18	43
140100.0404PS	6	1/4	04	1/4"-19	19	-	18	46
140100.0406PS	6	1/4	04	3/8"-19	22	-	19	47
140100.0506PS	8	5/16	05	3/8"-19	22	-	19	47
140100.0606PS	10	3/8	06	3/8"-19	22	-	20	50
140100.0608PS	10	3/8	06	1/2"-14	27	-	21	51
140100.0808PS	12	1/2	08	1/2"-14	27	-	22	55



BSP C90 Female free nut

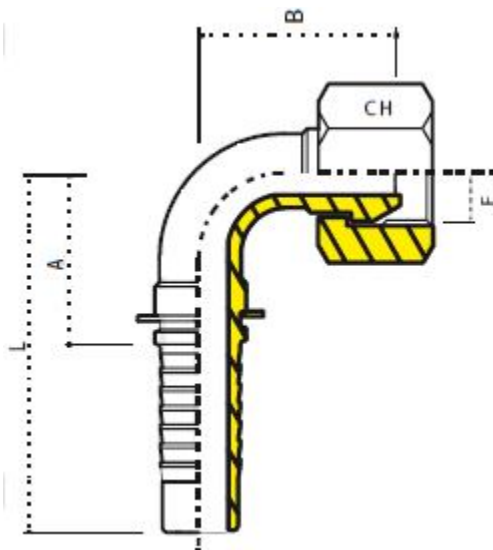

COD	FURTUN			FILET	DIMENSIUNI (MM)			
	DN	INCH	DIAM	F	CH	B	A	L
180102.0302PS	5	3/16	03	1/8"-28	15	29.0	23.0	47.5
180102.0304PS	5	3/16	03	1/4"-19	19	29.0	23.0	47.5
180102.0404PS	6	1/4	04	1/4"-19	19	29.0	23.0	51.0
180102.0406PS	6	1/4	04	3/8"-19	22	32.0	23.0	51.0
180102.0506PS	8	5/16	05	3/8"-19	22	35.5	31.5	59.5
180102.0606PS	10	3/8	06	3/8"-19	22	38.0	33.0	63.0
180102.0608PS	10	3/8	06	1/2"-14	27	42.0	33.0	63.0
180102.0808PS	12	1/2	08	1/2"-14	27	45.0	39.0	72.0

BSP C45 Female free nut

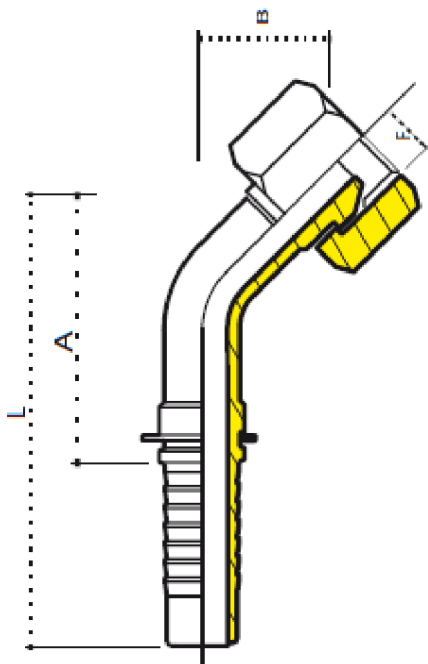

COD	FURTUN			FILET	DIMENSIUNI (MM)			
	DN	INCH	DIAM	F	CH	B	A	L
200103.0302PS	5	3/16	03	1/8"-28	15	17	40	65
200103.0304PS	5	3/16	03	1/4"-19	19	17	40	65
200103.0404PS	6	1/4	04	1/4"-19	19	17	40	68
200103.0406PS	6	1/4	04	3/8"-19	22	20	43	71
200103.0506PS	8	5/16	05	3/8"-19	22	21	52	80
200103.0606PS	10	3/8	06	3/8"-19	22	20	55	85
200103.0608PS	10	3/8	06	1/2"-14	27	23	58	88
200103.0808PS	12	1/2	08	1/2"-14	27	23	65	98



BSP C90 compact female 90 swept elbow

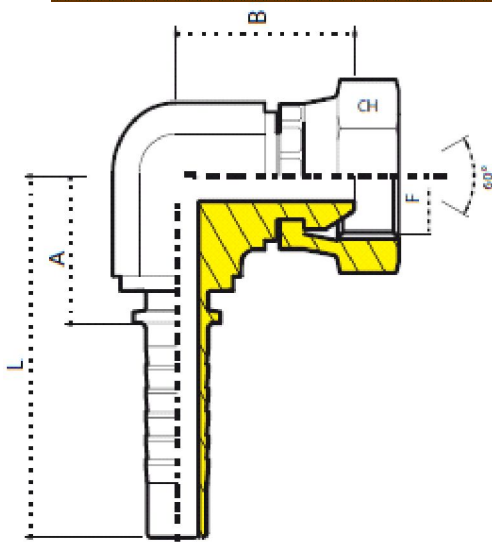

COD	FURTUN			FILET	DIMENSIUNI (MM)			
	DN	INCH	DIAM	F	CH	B	A	L
180200.0404	6	1/4	04	1/4"-19	19	25.0	19.0	48.0
180200.0406	6	1/4	04	3/8"-19	22	28.0	20.5	48.5
180200.0506	8	5/16	05	3/8"-19	22	28.0	20.5	48.5
180200.0606	10	3/8	06	3/8"-19	22	28.0	20.5	50.5
180200.0608	10	3/8	06	1/2"-14	27	34.0	23.5	53.5
180200.0808	12	1/2	08	1/2"-14	27	34.0	23.5	57.0
180200.1212	20	3/4	12	3/4"-14	32	39.5	25.0	64.0
180200.1616	25	1	16	1"-11	38	-	-	-

NPTF male 60

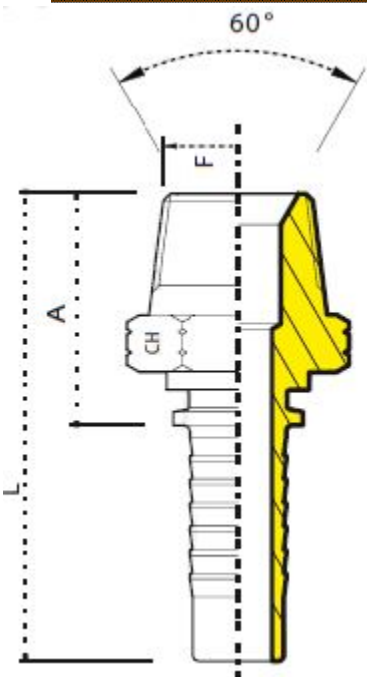

COD	FURTUN			FILET	DIMENSIUNI (MM)			
	DN	INCH	DIAM	F	CH	B	A	L
160401.0302	5	3/16	03	1/8"-28	12	-	22.0	47.0
160401.0304	5	3/16	03	1/4"-19	15	-	22.0	47.0
160401.0402	6	1/4	04	1/8"-28	12	-	22.5	50.5
160401.0404	6	1/4	04	1/4"-19	15	-	27.0	55.0
160401.0406	6	1/4	04	3/8"-19	19	-	28.0	56.0
160401.0504	8	5/16	05	1/4"-19	15	-	27.0	55.0
160401.0506	8	5/16	05	3/8"-19	19	-	28.0	56.0
160401.0508	8	5/16	05	1/2"-14	22	-	28.0	56.0
160401.0604	10	3/8	06	1/4"-19	15	-	28.0	56.0
160401.0606	10	3/8	06	3/8"-19	19	-	28.0	58.0
160401.0608	10	3/8	06	1/2"-14	22	-	34.0	67.5
160401.0806	12	1/2	08	3/8"-19	19	-	28.0	63.0
160401.0808	12	1/2	08	1/2"-14	22	-	34.5	67.5
160401.0812	12	1/2	08	3/4"-14	27	-	34.5	67.5
160401.1012	16	5/8	10	3/4"-14	27	-	36.5	72.5
160401.1212	16	3/4	12	3/4"-14	27	-	37.0	78.0
160401.1216	20	3/4	12	1"-11	36	-	45.0	86.0
160401.1612	20	1	08	3/4"-14	27	-	38.0	93.0
160401.1616	25	1	10	1"-11	36	-	46.0	101.0
160401.1620	25	1	10	1.1/4"-11	46	-	45.5	100.0
160401.2020	32	1.1/4	12	1.1/4"-11	46	-	45.5	106.5
160401.2424	40	1.1/2	12	1.1/2"-11	50	-	47.0	118.0
160401.3232	50	2	12	2"-11	65	-	57.0	137.00



JIC male 74

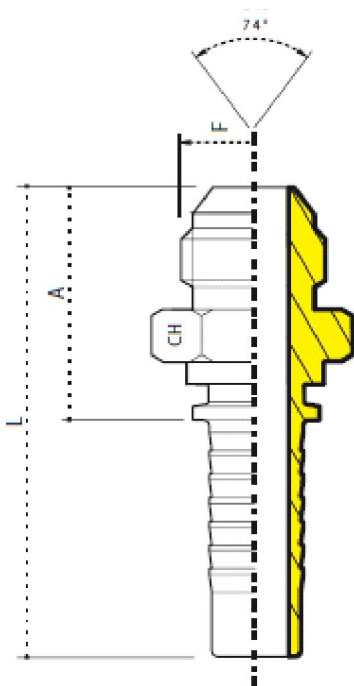

COD	FURTUN			FILET	DIMENSIUNI (MM)			
	DN	INCH	DIAM	F	CH	B	A	L
160501.0304	5	3/16	03	7/16"-20	12	-	27.0	51.5
160501.0305	6	3/16	03	1/2"-20	14	-	27.0	51.5
160501.0404	6	1/4	04	7/16"-20	12	-	27.0	55.0
160501.0405	6	1/4	04	1/2"-20	14	-	27.0	55.0
160501.0406	6	1/4	04	9/16-18	15	-	28.0	56.0
160501.0505	8	5/16	05	1/2"-20	14	-	27.0	55.0
160501.0506	8	5/16	05	9/16"-18	15	-	28.0	56.0
160501.0507	8	5/16	05	5/8"-18	19	-	29.5	57.5
160501.0508	8	5/16	05	3/4-16	15	-	28.0	56.0
160501.0606	10	3/8	06	9/16"-18	19	-	28.0	58.0
160501.0607	10	3/8	06	5/8"-18	17	-	29.5	59.5
160501.0608	10	3/8	06	3/4"-16	19	-	30.5	60.5
160501.0610	10	3/8	06	7/8"-14	24	-	34.5	64.5
160501.0808	12	1/2	08	3/4"-16	19	-	31.0	64.0
160501.0810	12	1/2	08	7/8"-14	24	-	35.0	68.0
160501.0812	12	1/2	08	1.1/16"-12	27	-	39.5	72.5
160501.1010	16	5/8	10	7/8"-14	24	-	35.0	71.0
160501.1012	16	5/8	10	1.1/16"-12	27	-	39.5	75.5
160501.1210	20	3/4	12	7/8"-14	-	-	-	-
160501.1212	20	3/4	12	1.16"-12	27	-	40.5	81.5
160501.1214	20	3/4	12	1.3/16"-12	32	-	41.5	82.5
160501.1216	20	3/4	12	1.5/16"-12	34	-	41.5	82.5
160501.1612	25	1	16	1.1/16"-12	-	-	-	-
160501.1616	25	1	16	1.5/16"-12	34	-	42.5	97.5
160501.1620	25	1	16	1.5/8"-12	42	-	45.0	100.0
160501.2020	32	1.1/4	20	1.5/8"-12	42	-	45.5	106.0
160501.2024	32	1.1/4	20	1.7/8"-12	50	-	52.5	113.0
160501.2424	40	1.1/2	24	1.7/8"-12	50	-	52.5	123.5
160501.3232	50	2	32	2.1/2"-12	-	-	-	-



JIC female 74

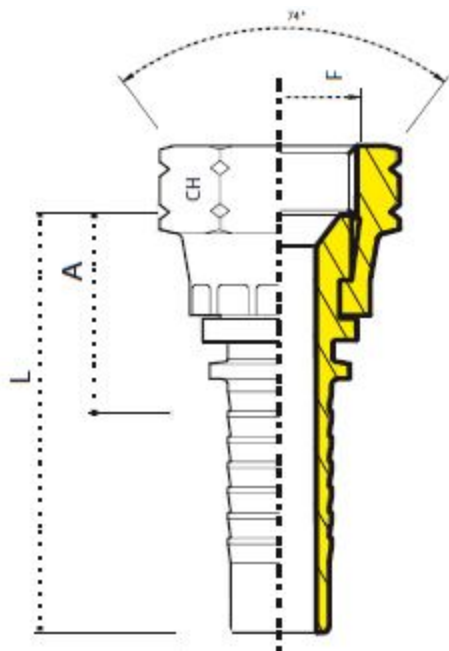

COD	FURTUN			FILET	DIMENSIUNI (MM)			
	DN	INCH	DIAM	F	CH	B	A	L
140500.0304	5	3/16	03	7/16"-20	15	-	15.0	40.0
140500.0305	6	3/16	03	1/2"-20	17	-	15.0	40.0
140500.0404	6	1/4	04	7/16"-20	15	-	15.0	43.0
140500.0405	6	1/4	04	1/2"-20	17	-	16.0	44.0
140500.0406	6	1/4	04	9/16-18	19	-	16.0	44.0
140500.0505	8	5/16	05	1/2"-20	17	-	16.0	44.0
140500.0506	8	5/16	05	9/16"-18	19	-	16.0	44.0
140500.0507	8	5/16	05	5/8"-18	22	-	17.0	45.0
140500.0508	8	5/16	05	3/4"-16	24	-	17.0	45.0
140500.0606	10	3/8	06	9/16"-18	19	-	16.5	46.5
140500.0607	10	3/8	06	5/8"-18	22	-	17.0	47.0
140500.0608	10	3/8	06	3/4"-16	24	-	17.0	47.0
140500.0610	10	3/8	06	7/8"-14	27	-	18.5	48.5
140500.0808	12	1/2	08	3/4"-16	24	-	18.0	51.0
140500.0810	12	1/2	08	7/8"-14	27	-	19.0	52.0
140500.0812	12	1/2	08	1.1/16"-12	32	-	22.0	55.0
140500.1010	16	5/8	10	7/8"-14	27	-	19.5	55.5
140500.1012	16	5/8	10	1.1/16"-12	32	-	22.5	58.5
140500.1210	20	3/4	12	7/8"-14	-	-	-	-
140500.1212	20	3/4	12	1.16"-12	32	-	23.0	64.0
140500.1214	20	3/4	12	1.3/16"-12	36	-	23.0	64.0
140500.1216	20	3/4	12	1.5/16"-12	41	-	23.0	64.0
140500.1612	25	1	16	1.1/16"-12	-	-	-	-
140500.1616	25	1	16	1.5/16"-12	41	-	24.5	79.5
140500.1620	25	1	16	1.5/8"-12	50	-	28.5	83.5
140500.2020	32	1.1/4	20	1.5/8"-12	50	-	29.0	90.0
140500.2024	32	1.1/4	20	1.7/8"-12	55	-	31.0	92.0
140500.2424	40	1.1/2	24	1.7/8"-12	55	-	31.0	102.0
140500.3232	50	2	32	2.1/2"-12	70	-	33.0	104.0





JIC C90 female swept elbow 74 cone seat

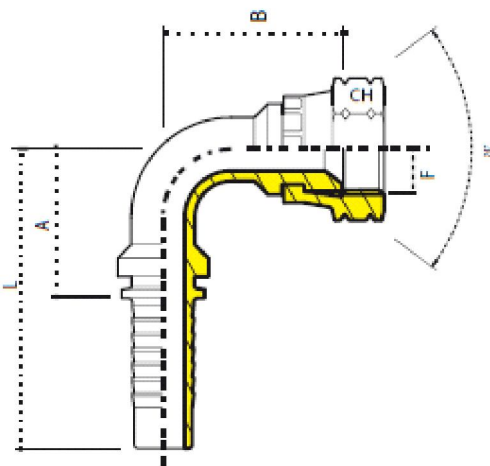

COD	FURTUN			FILET	DIMENSIUNI (MM)			
	DN	INCH	DIAM	F	CH	B	A	L
180502.0304	5	3/16	03	7/16"-20	15	26.0	23.0	47.5
180502.0305	5	3/16	03	1/2"-20	17	27.0	23.0	47.5
180502.0404	6	1/4	04	7/16"-20	15	26.0	23.0	51.0
180502.0405	6	1/4	04	1/2"-20	17	27.0	23.0	51.0
180502.0406	6	1/4	04	9/16"-18	19	27.0	23.0	51.0
180502.0505	8	5/16	05	1/2"-20	17	32.0	31.5	59.5
180502.0506	8	5/16	05	9/16"-18	19	32.0	31.5	59.5
180502.0507	8	5/16	05	5/8"-18	22	32.5	31.5	59.5
180502.0508	8	5/16	05	3/4"-16	24	32.5	31.5	59.5
180502.0606	10	3/8	06	9/16"-18	19	35.0	33.0	63.0
180502.0607	10	3/8	06	5/8"-18	22	35.5	33.0	63.0
180502.0608	10	3/8	06	3/4"-16	24	36.5	33.0	63.0
180502.0610	10	3/8	06	7/8"-14	27	39.5	33.0	63.0
180502.0808	12	1/2	08	3/4"-16	24	41.0	39.0	72.0
180502.0810	12	1/2	08	7/8"-14	27	42.5	39.0	72.0
180502.0812	12	1/2	08	1.1/16"-12	32	50.0	39.0	72.0
180502.1010	16	5/8	10	7/8"-14	27	50.0	49.0	85.0
180502.1012	16	5/8	10	1.1/16"-12	32	55.0	22.5	85.0
180502.1210	20	3/4	12	7/8"-14	-	-	-	-
180502.1212	20	3/4	12	1.16"-12	32	58.0	53.5	94.5
180502.1214	20	3/4	12	1.3/16"-12	36	61.0	53.5	94.5
180502.1216	20	3/4	12	1.5/16"-12	41	62.5	53.5	94.5
180502.1612	25	1	16	1.1/16"-12	-	-	-	-
180502.1616	25	1	16	1.5/16"-12	41	69.5	73.0	128.0
180502.1620	25	1	16	1.5/8"-12	50	78.5	73.0	128.0
180502.2020	32	1.1/4	20	1.5/8"-12	50	91.5	89.0	150.0
180502.2024	32	1.1/4	20	1.7/8"-12	55	99.0	89.0	150.0
180502.2424	40	1.1/2	24	1.7/8"-12	55	112.5	101.0	172.0
180502.3232	50	2	32	2.1/2"-12	-	-	-	-



JIC C45 Female swept elbow 74 cone seat

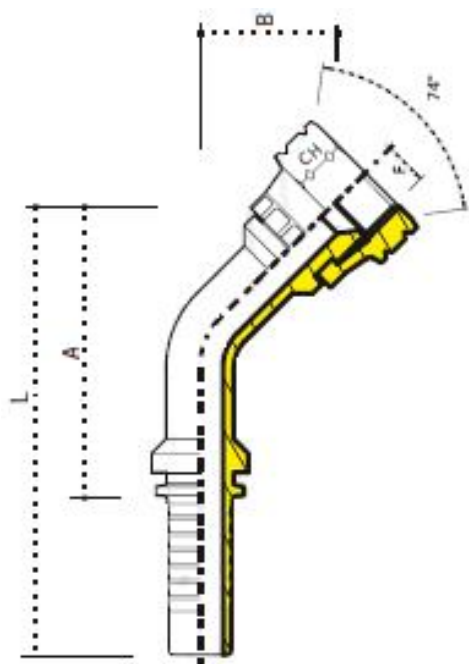

COD	FURTUN			FILET	DIMENSIUNI (MM)			
	DN	INCH	DIAM	F	CH	B	A	L
200503.0304	5	3/16	03	7/16"-20	15	15.0	38.0	63.0
200503.0305	5	3/16	03	1/2"-20	17	17.0	40.0	65.0
200503.0404	6	1/4	04	7/16"-20	15	15.0	38.0	66.0
200503.0405	6	1/4	04	1/2"-20	17	17.0	40.0	68.0
200503.0406	6	1/4	04	9/16"-18	19	16.5	39.5	67.5
200503.0505	8	5/16	05	1/2"-20	17	17.0	40.0	68.0
200503.0506	8	5/16	05	9/16"-18	19	18.5	49.5	77.5
200503.0507	8	5/16	05	5/8"-18	22	19.0	50.0	80.0
200503.0508	8	5/16	05	3/4"-16	24	19.5	50.5	78.5
200503.0606	10	3/8	06	9/16"-18	19	18.0	53.0	83.0
200503.0607	10	3/8	06	5/8"-18	22	19.0	54.0	84.0
200503.0608	10	3/8	06	3/4"-16	24	19.0	54.0	84.0
200503.0610	10	3/8	06	7/8"-14	27	21.0	56.0	86.0
200503.0808	12	1/2	08	3/4"-16	24	20.0	62.0	95.0
200503.0810	12	1/2	08	7/8"-14	27	21.0	63.0	97.0
200503.0812	12	1/2	08	1.1/16"-12	32	22.0	64.0	97.0
200503.1010	16	5/8	10	7/8"-14	27	22.0	60.0	96.0
200503.1012	16	5/8	10	1.1/16"-12	32	25.0	63.0	99.0
200503.1210	20	3/4	12	7/8"-14	-	-	-	-
200503.1212	20	3/4	12	1.1/16"-12	32	29.0	62.0	103.0
200503.1214	20	3/4	12	1.3/16"-12	36	29.0	63.0	103.0
200503.1216	20	3/4	12	1.5/16"-12	41	29.0	63.0	103.0
200503.1612	25	1	16	1.1/16"-12	-	-	-	-
200503.1616	25	1	16	1.5/16"-12	41	39.5	88.5	143.5
200503.1620	25	1	16	1.5/8"-12	50	38.5	89.5	147.5
200503.2020	32	1.1/4	20	1.5/8"-12	50	44.0	101.0	162.0
200503.2024	32	1.1/4	20	1.7/8"-12	55	45.0	103.0	164.0
200503.2424	40	1.1/2	24	1.7/8"-12	55	45.0	118.0	189.0
200503.3232	50	2	32	2.1/2"-12	-	-	-	-



JIS Metric female 60

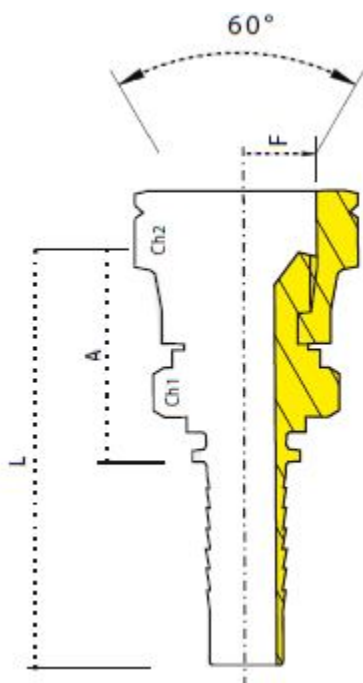

COD	FURTUN			FILET	DIMENSIUNI (MM)			
	DN	INCH	DIAM	F	CH	B	A	L
144900.0414	6	1/4	-	M14x1.5	19	-	24.2	52.2
144900.0516	8	5/16	-	M16x1.5	22	-	24.2	52.2
144900.0614	10	3/8	-	M14x1.5	19	-	24.2	54.2
144900.0616	10	3/8	-	M16x1.5	22	-	24.2	54.2
144900.0618	10	3/8	-	M18x1.5	24	-	25.8	55.8
144900.0820	12	1/2	-	M20x1.5	27	-	29.0	62.0
144900.0822	12	1/2	-	M22x1.5	27	-	29.0	62.0
144900.0824	12	1/2	-	M24x1.5	32	-	32.0	65.0
144900.1022	16	5/8	-	M22x1.5	27	-	29.0	65.0
144900.1024	16	5/8	-	M24x1.5	32	-	32.5	68.5
144900.1230	20	3/4	-	M30x1.5	36	-	32.1	73.1
144900.1633	25	1	-	M33x1.5	41	-	34.6	89.6
144900.2036	32	1.1/4	-	M36x1.5	46	-	37.5	96.6
144900.2442	40	1.1/2	-	M42x1.5	50	-	36.1	107.1

JIS BSP female 60

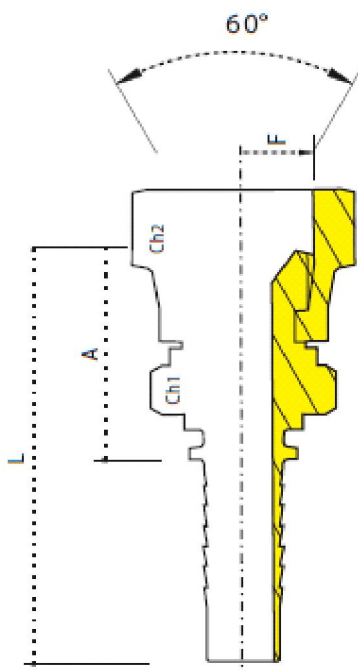

COD	FURTUN			FILET	DIMENSIUNI (MM)			
	DN	INCH	DIAM	F	CH	B	A	L
144600.0404	6	1/4	-	1/4-19	-	-	-	-
144600.0606	10	3/8	-	3/8-19	-	-	-	-
144600.0808	12	1/2	-	1/2-14	-	-	-	-
144600.1010								
144600.1212	20	3/4	-	3/4-14	-	-	-	-
144600.1616	25	1	-	1"-11	-	-	-	-
144600.2020	32	1.1/4	-	1.1/4-11	-	-	-	-



ORFS male

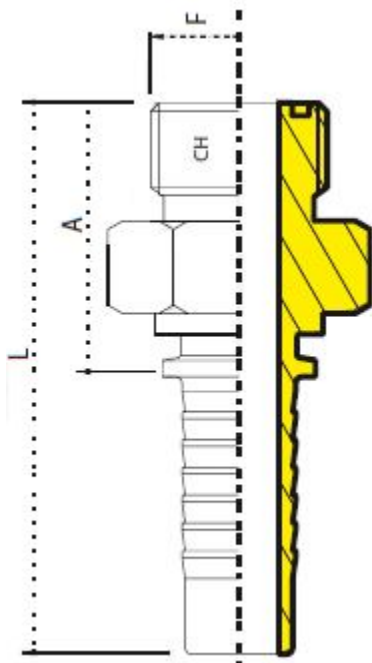

COD	FURTUN			FILET	DIMENSIUNI (MM)			
	DN	INCH	DIAM	F	CH	B	A	L
163601.0404	6	1/4	04	9/16"-18	17	-	24.0	52.0
163601.0406	6	1/4	04	11/16"-16	19	-	27.5	55.5
163601.0506	8	5/16	05	11/16"-16	19	-	27.5	55.5
163601.0606	10	3/8	06	11/16"-16	19	-	27.5	57.5
163601.0608	10	3/8	06	13/16"-16	22	-	30.5	60.5
163601.0808	10	3/8	06	1"-14	27	-	33.5	63.5
163601.0810	12	1/2	08	13/16"-14	27	-	34.0	67.0
163601.0812	12	1/2	08	1"-14	27	-	31.5	67.0
163601.1008	12	1/2	08	1.3/16"-12	32	-	36.0	68.5
163601.1010	16	5/8	10	1"-14	27	-	34.0	70.0
163601.1012	16	5/8	10	1.3/16"-12	32	-	37.0	73.0
163601.1212	20	3/4	12	1.3/16"-12	32	-	38.0	79.0
163601.1216	20	3/4	12	1.7/16"-12	41	-	38.5	79.5
163601.1616	25	1	16	1.7/16"-12	41	-	39.5	94.0
163601.2016	32	1.1/4	20	1.7/16"-12	46	-	40.0	101.0
163601.2020	40	1.1/2	24	1.11/16"-12	55	-	43.0	114.0

ORFS female

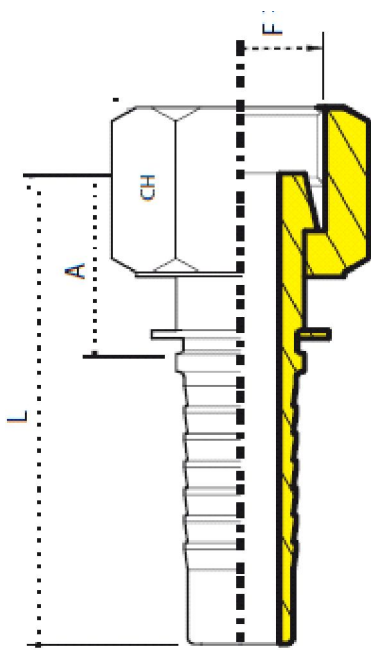

COD	FURTUN			FILET	DIMENSIUNI (MM)			
	DN	INCH	DIAM	F	CH	B	A	L
143600.0404	6	1/4	04	9/16"-18	17	-	20.5	48.5
143600.0406	6	1/4	04	11/16"-16	22	-	23.0	51.0
143600.0506	8	5/16	05	11/16"-16	22	-	23.0	51.0
143600.0606	10	3/8	06	11/16"-16	22	-	23.5	53.5
143600.0608	10	3/8	06	13/16"-16	22	-	26.0	56.0
143600.0810	12	1/2	08	13/16"-14	24	-	26.5	59.5
143600.0812	12	1/2	08	1"-14	30	-	30.0	63.0
143600.1008	12	1/2	08	1.3/16"-12	36	-	32.5	65.0
143600.1010	16	5/8	10	1"-14	30	-	30.0	66.0
143600.1012	16	5/8	10	1.3/16"-12	36	-	32.0	68.5
143600.1212	20	3/4	12	1.3/16"-12	36	-	33.0	74.0
143600.1216	20	3/4	12	1.7/16"-12	41	-	34.0	75.0
143600.1616	25	1	16	1.7/16"-12	41	-	35.0	90.0
143600.2016	32	1.1/4	20	1.7/16"-12	52	-	35.5	96.0
143600.2020	40	1.1/2	24	1.11/16"-12	60	-	37.0	108.0



ORFS 90 female

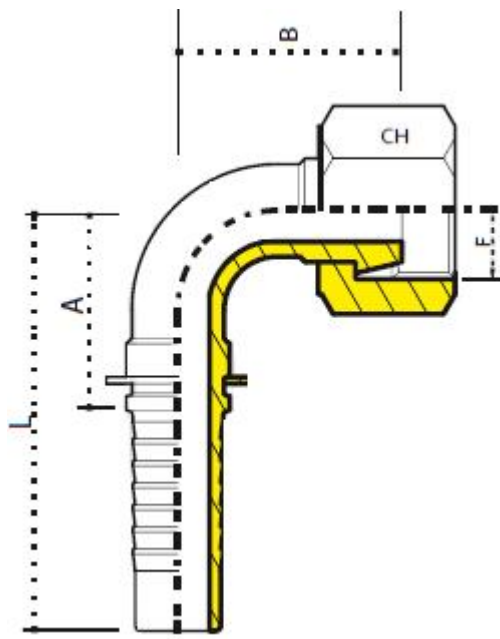

COD	FURTUN			FILET	DIMENSIUNI (MM)			
	DN	INCH	DIAM	F	CH	B	A	L
163602.0404	6	1/4	04	9/16"-18	17	29.5	28.0	56.0
163602.0406	6	1/4	04	11/16"-16	22	30.0	28.0	56.0
163602.0506	8	5/16	05	11/16"-16	22	29.0	29.0	56.5
163602.0606	10	3/8	06	11/16"-16	22	29.0	36.0	66.0
163602.0608	10	3/8	06	13/16"-16	22	32.0	34.0	64.0
163602.0810	12	1/2	08	13/16"-14	24	36.0	37.5	70.5
163602.0812	12	1/2	08	1"-14	30	39.0	39.0	72.0
163602.1008	12	1/2	08	1.3/16"-12	36	41.0	38.0	71.0
163602.1010	16	5/8	10	1"-14	30	43.5	51.5	87.5
163602.1012	16	5/8	10	1.3/16"-12	36	48.0	46.5	82.5
163602.1212	20	3/4	12	1.3/16"-12	36	49.0	56.0	96.5
163602.1216	20	3/4	12	1.7/16"-12	41	54.0	56.5	97.0
163602.1616	25	1	16	1.7/16"-12	41	59.5	74.0	129.0
163602.2016	32	1.1/4	20	1.7/16"-12	50	75.5	90.0	150.5
163602.2020	40	1.1/2	24	1.11/16"-12	60	84.0	99.0	170.0

ORFS 45 female

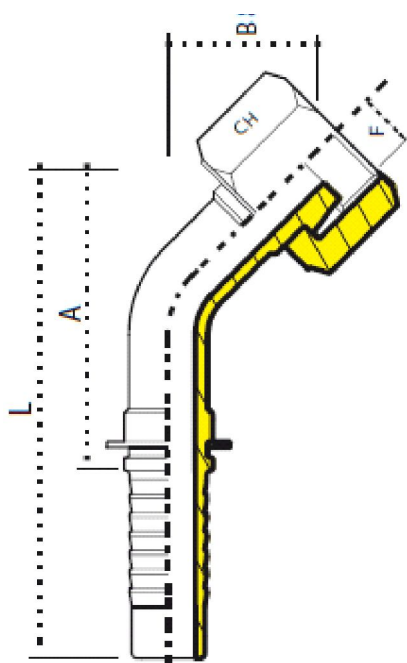

COD	FURTUN			FILET	DIMENSIUNI (MM)			
	DN	INCH	DIAM	F	CH	B	A	L
203603.0404	6	1/4	04	9/16"-18	17	15.0	45.0	73.0
203603.0406	6	1/4	04	11/16"-16	22	15.5	45.5	73.5
203603.0506	8	5/16	05	11/16"-16	22	15.5	46.0	74.0
203603.0606	10	3/8	06	11/16"-16	22	13.0	51.0	81.0
203603.0608	10	3/8	06	13/16"-16	22	17.0	52.0	82.0
203603.0810	12	1/2	08	13/16"-14	24	18.0	58.0	91.0
203603.0812	12	1/2	08	1"-14	30	20.0	61.0	94.0
203603.1008	12	1/2	08	1.3/16"-12	36	24.0	62.0	95.0
203603.1010	16	5/8	10	1"-14	30	20.0	55.0	91.0
203603.1012	16	5/8	10	1.3/16"-12	36	21.0	57.0	93.0
203603.1212	20	3/4	12	1.3/16"-12	36	23.0	58.0	98.0
203603.1216	20	3/4	12	1.7/16"-12	41	27.0	62.5	103.0
203603.1616	25	1	16	1.7/16"-12	41	26.0	81.0	136.0
203603.2016	32	1.1/4	20	1.7/16"-12	50	34.0	93.0	152.5
203603.2020	40	1.1/2	24	1.11/16"-12	60	45.0	112.0	182.0





Metric male 24 cone I.T.

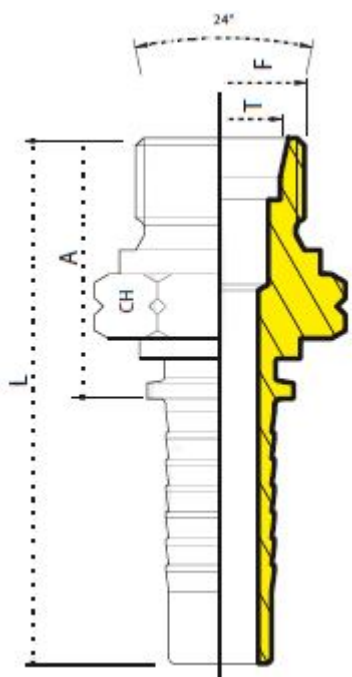

COD	FURTUN			FILET	DIMENSIUNI (MM)			
	DN	INCH	DIAM	F	CH	B	A	L
161201.0312	5	3/16	03	M12X1.5	15	-	22.5	50.0
161201.0314	5	3/16	03	M14X1.5	15	-	23.0	51.0
161201.0412	6	1/4	04	M12X1.5	15	-	23.0	51.0
161201.0414	6	1/4	04	M14X1.5	15	-	23.0	51.0
161201.0416	6	1/4	04	M16X1.5	17	-	25.0	53.0
161201.0418	6	1/4	04	M18X1.5	19	-	26.0	54.0
161201.0516	8	5/16	05	M16X1.5	17	-	25.0	53.0
161201.0518	8	5/16	05	M18X1.5	19	-	26.0	54.0
161201.0616	10	3/8	06	M16X1.5	17	-	25.0	55.0
161201.0618	10	3/8	06	M18X1.5	19	-	25.0	55.5
161201.0622	10	3/8	06	M22X1.5	24	-	27.0	57.0
161201.0822	12	1/2	08	M22X1.5	24	-	27.5	60.5
161201.0826	12	1/2	08	M26X1.5	27	-	27.5	60.5
161201.1026	16	5/8	10	M26X1.5	27	-	27.5	63.5
161201.1030	16	5/8	10	M30X2	32	-	31.5	67.0
161201.1226	19	3/4	12	M26X1.5	27	-	29.0	68.5
161201.1230	19	3/4	12	M30X2	32	-	32.0	73.0
161201.1636	25	1	16	M36X2	38	-	40.0	92.5
161201.2045	32	1.1/4	20	M45X2	46	-	41.5	101.5
161201.2452	40	1.1/2	24	M52X2	55	-	40.0	107.0





O'ring metric female 24 cone 24 I.T.

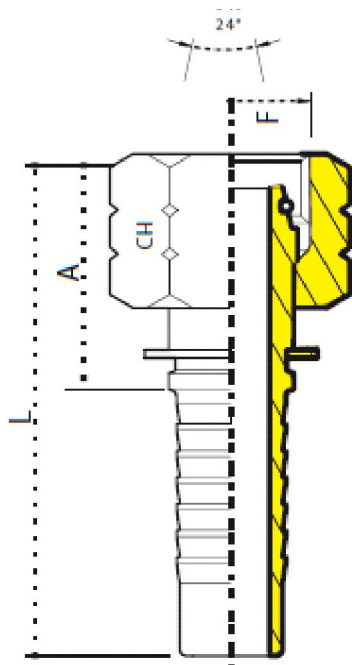

COD	FURTUN			FILET	DIMENSIUNI (MM)			
	DN	INCH	DIAM	F	CH	B	A	L
141200.0312	5	3/16	03	M12X1.5	14	-	25.5	50.0
141200.0314	5	3/16	03	M14X1.5	17	-	25.5	50.0
141200.0412	6	1/4	04	M12X1.5	14	-	21.0	48.5
141200.0414	6	1/4	04	M14X1.5	17	-	23.5	53.0
141200.0416	6	1/4	04	M16X1.5	19	-	26.0	54.0
141200.0418	6	1/4	04	M18X1.5	22	-	26.0	54.0
141200.0516	8	5/16	05	M16X1.5	19	-	26.0	54.0
141200.0518	8	5/16	05	M18X1.5	22	-	26.0	54.0
141200.0616	10	3/8	06	M16X1.5	19	-	23.5	53.5
141200.0618	10	3/8	06	M18X1.5	22	-	26.5	56.5
141200.0622	10	3/8	06	M22X1.5	27	-	27.0	57.0
141200.0822	12	1/2	08	M22X1.5	27	-	27.5	60.5
141200.0826	12	1/2	08	M26X1.5	32	-	28.0	61.0
141200.1026	16	5/8	10	M26X1.5	32	-	30.0	64.0
141200.1030	16	5/8	10	M30X2	36	-	31.0	66.5
141200.1226	19	3/4	12	M26X1.5	-	-	-	-
141200.1230	19	3/4	12	M30X2	36	-	31.0	72.0
141200.1636	25	1	16	M36X2	41	-	33.5	88.5
141200.2045	32	1.1/4	20	M45X2	50	-	38.5	99.0
141200.2452	40	1.1/2	24	M52X2	60	-	39.0	109.5



90 O'ring metric swept elbow cone 24 I.T.

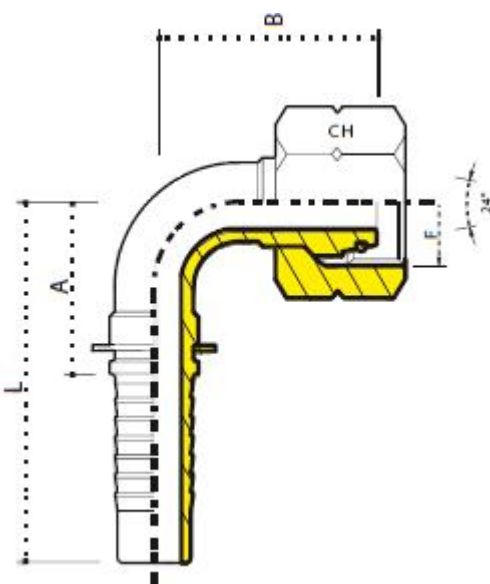

COD	FURTUN			FILET	DIMENSIUNI (MM)			
	DN	INCH	DIAM	F	CH	B	A	L
181202.0312	5	3/16	03	M12X1.5	14	31.5	29.5	53.5
181202.0314	5	3/16	03	M14X1.5	17	31.5	29.5	53.5
181202.0412	6	1/4	04	M12X1.5	14	31.5	29.5	57.0
181202.0414	6	1/4	04	M14X1.5	17	31.5	29.0	57.0
181202.0416	6	1/4	04	M16X1.5	19	32.5	27.0	56.5
181202.0418	6	1/4	04	M18X1.5	22	30.5	31.0	55.0
181202.0516	8	5/16	05	M16X1.5	19	32.5	29.0	59.0
181202.0518	8	5/16	05	M18X1.5	22	37.0	33.0	57.0
181202.0616	10	3/8	06	M16X1.5	19	28.0	35.5	63.0
181202.0618	10	3/8	06	M18X1.5	22	37.5	34.0	65.0
181202.0622	10	3/8	06	M22X1.5	27	42.0	39.5	64.0
181202.0822	12	1/2	08	M22X1.5	27	44.0	39.5	72.0
181202.0826	12	1/2	08	M26X1.5	32	46.5	48.5	72.0
181202.1026	16	5/8	10	M26X1.5	32	50.5	48.5	84.0
181202.1030	16	5/8	10	M30X2	36	53.0	48.5	84.0
181202.1226	19	3/4	12	M26X1.5	-	-	-	-
181202.1230	19	3/4	12	M30X2	36	55.5	56.5	97.0
181202.1636	25	1	16	M36X2	41	72.5	73.0	127.0
181202.2045	32	1.1/4	20	M45X2	50	86.5	92.0	152.0
181202.2452	40	1.1/2	24	M52X2	60	94.0	99.0	170.0



45 O'ring metric swept elbow cone 24 I.T.

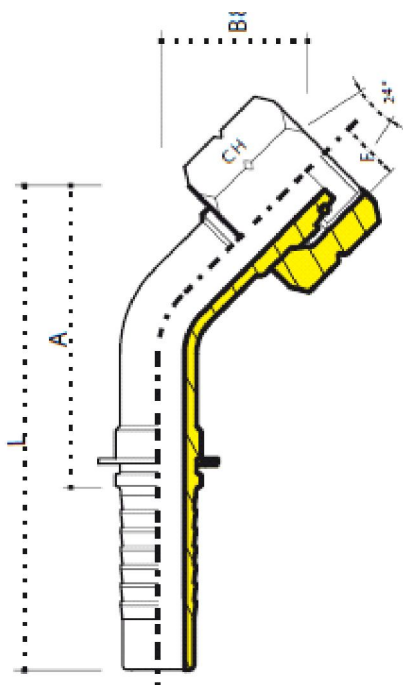

COD	FURTUN			FILET	DIMENSIUNI (MM)			
	DN	INCH	DIAM	F	CH	B	A	L
201203.0312	5	3/16	03	12X1.5	14	15.0	37.0	65.0
201203.0314	5	3/16	03	14X1.5	17	15.0	37.0	65.0
201203.0412	6	1/4	04	12X1.5	14	17.0	40.0	68.0
201203.0414	6	1/4	04	14X1.5	17	17.0	50.0	78.0
201203.0416	6	1/4	04	16X1.5	19	17.0	48.5	76.0
201203.0418	6	1/4	04	18X1.5	22	17.0	48.5	76.0
201203.0516	8	5/16	05	16X1.5	19	17.0	52.5	80.0
201203.0518	8	5/16	05	18X1.5	22	20.0	50.0	78.0
201203.0616	10	3/8	06	16X1.5	19	20.0	55.0	85.0
201203.0618	10	3/8	06	18X1.5	22	17.0	57.0	86.5
201203.0622	10	3/8	06	22X1.5	27	19.0	59.0	88.5
201203.0822	12	1/2	08	22X1.5	27	22.0	64.0	97.0
201203.0826	12	1/2	08	26X1.5	32	26.0	65.0	98.0
201203.1026	16	5/8	10	26X1.5	32	28.0	61.5	97.0
201203.1030	16	5/8	10	30X2	36	30.0	63.5	99.0
201203.1226	19	3/4	12	26X1.5	-	-	-	-
201203.1230	19	3/4	12	30X2	36	27.0	63.0	103.5
201203.1636	25	1	16	36X2	41	38.5	85.5	140.0
201203.2045	32	1.1/4	20	45X2	50	35.0	104.5	164.5
201203.2452	40	1.1/2	24	52X2	60	45.0	119.0	189.0





Metric male 24 cone H.T.

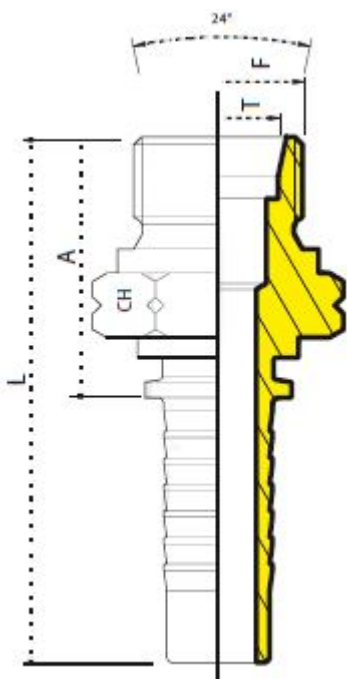

COD	FURTUN			FILET	DIMENSIUNI (MM)			
	DN	INCH	DIAM	F	CH	B	A	L
162201.0314	3/16	03	M14X1.5		14	-	24.0	50.0
162201.0316	3/16	03	M16X1.5		17	-	25.0	50.0
162201.0414	1/4	04	M14X1.5		14	-	24.0	53.0
162201.0416	1/4	04	M16X1.5		17	-	25.0	53.0
162201.0418	1/4	04	M18X1.5		19	-	25.0	53.0
162201.0420	1/4	04	M20X1.5		22	-	27.0	55.0
162201.0518	5/16	05	M18X1.5		19	-	25.0	53.0
162201.0520	5/16	05	M20X1.5		22	-	26.5	55.0
162201.0618	3/8	06	M18X1.5		19	-	26.0	55.0
162201.0620	3/8	06	M20X1.5		22	-	27.0	57.0
162201.0622	3/8	06	M22X1.5		24	-	29.0	59.5
162201.0822	1/2	08	M22X1.5		24	-	30.0	63.0
162201.0824	1/2	08	M24X1.5		27	-	31.0	64.0
162201.1030	5/8	10	M30X2		32	-	33.0	69.0
162201.1230	3/4	12	M30X2		32	-	34.0	75.0
162201.1236	3/4	12	M36X2		38	-	36.0	76.5
162201.1636	1	16	M36X2		38	-	38.5	93.5
162201.1642	1	16	M42X2		46	-	42.0	96.0
162201.2042	1.1/4	20	M42X2		46	-	42.0	103.0
162201.2052	1.1/4	20	M52X2		55	-	46.0	105.0
162201.2452	1.1/2	24	M52X2		55	-	46.0	117.0





O'ring metric female 24 cone 24 H.T.

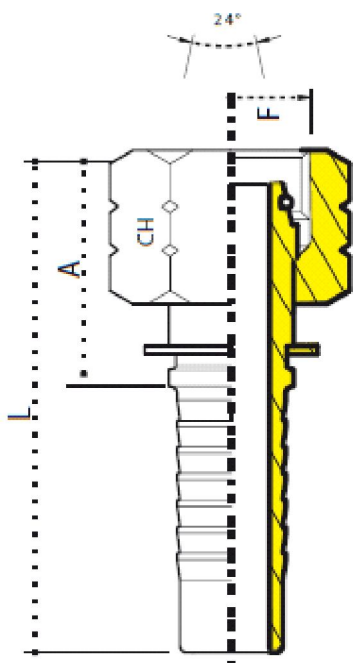

COD	FURTUN			FILET	DIMENSIUNI (MM)			
	DN	INCH	DIAM	F	CH	B	A	L
142200.0312	5	3/16	03	M14X1.5	17	-	25.5	50.0
142200.0314	5	3/16	03	M16X1.5	19	-	25.5	50.0
142200.0412	6	1/4	04	M14X1.5	17	-	25.5	53.0
142200.0414	6	1/4	04	M16X1.5	19	-	26	54.0
142200.0416	6	1/4	04	M16X1.5	22	-	26	54.0
142200.0418	6	1/4	04	M18X1.5	24	-	26	54.0
142200.0516	8	5/16	05	M20X1.5	22	-	26.5	54.5
142200.0518	8	5/16	05	M18X1.5	24	-	26	54.0
142200.0616	10	3/8	06	M20X1.5	22	-	26.5	56.5
142200.0618	10	3/8	06	M18X1.5	24	-	26.5	54.5
142200.0622	10	3/8	06	M20X1.5	27	-	27	57.0
142200.0822	12	1/2	08	M22X1.5	27	-	27.5	60.5
142200.0826	12	1/2	08	M24X1.5	30	-	32	65.0
142200.1026	16	5/8	10	M30X2	36	-	37	73.0
142200.1030	16	5/8	10	M30X2	36	-	37.5	78.5
142200.1226	19	3/4	12	M36X2	46	-	38.5	79.5
142200.1230	19	3/4	12	M36X2	46	-	39.5	94.5
142200.1636	25	1	16	M42X2	50	-	40.5	95.5
142200.2045	32	1.1/4	20	M42X2	50	-	41.5	102.0
142200.2045	32	1.1/4	20	M52X2	60	-	47	107.5
142200.2452	40	1.1/2	24	M52X2	60	-	47	118.0



C90 90 O'ring metric swept elbow cone 24 H.T.

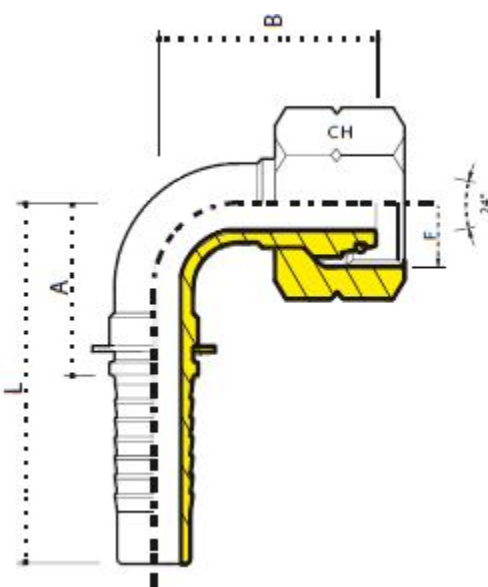

COD	FURTUN			FILET	DIMENSIUNI (MM)			
	DN	INCH	DIAM	F	CH	B	A	L
182202.0314	5	3/16	03	M14X1.5	17	31.5	29.5	53.5
182202.0316	5	3/16	03	M16X1.5	19	31.5	29.5	53.5
182202.0414	6	1/4	04	M14X1.5	17	31.5	29.5	57.0
182202.0416	6	1/4	04	M16X1.5	19	31.5	29.5	57.0
182202.0418	6	1/4	04	M18X1.5	22	32.5	29.0	56.5
182202.0420	6	1/4	04	M20X1.5	24	30.5	27.0	55.0
182202.0518	8	5/16	05	M18X1.5	22	32.5	31.0	59.0
182202.0520	8	5/16	05	M20X1.5	24	37.0	29.0	57.0
182202.0618	10	3/8	06	M18X1.5	22	38.0	33.0	63.0
182202.0620	10	3/8	06	M20X1.5	24	37.5	35.5	65.0
182202.0622	10	3/8	06	M22X1.5	27	42.0	34.0	64.0
182202.0822	12	1/2	08	M22X1.5	27	44.0	39.5	72.0
182202.0824	12	1/2	08	M24X1.5	30	45.0	39.5	72.0
182202.1030	16	5/8	10	M30X2	36	56.0	48.5	84.0
182202.1230	19	3/4	12	M30X2	36	59.0	56.5	97.0
182202.1236	19	3/4	12	M36X2	46	59.0	56.5	97.0
182202.1636	25	1	16	M36X2	46	75.0	73.0	127.0
182202.1642	25	1	16	M42X2	50	75.0	73.0	127.0
182202.2042	32	1.1/4	20	M42X2	50	86.0	92.0	152.0
182202.2052	32	1.1/4	20	M52X2	60	86.0	96.0	152.0
182202.2452	40	1.1/2	24	M52X2	60	94.0	99.0	170.0



C45 90 O'ring metric swept elbow cone 24 H.T.

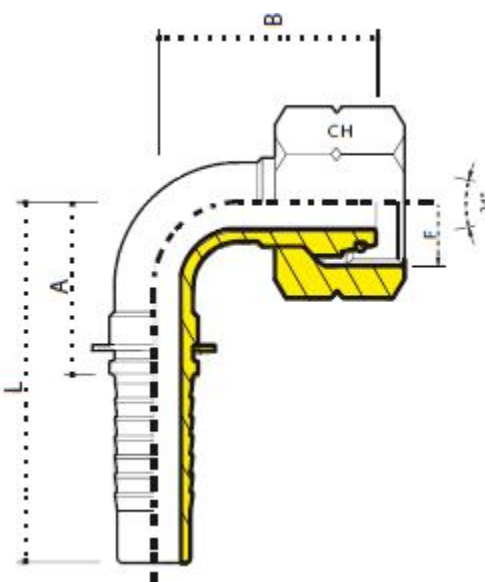

COD	FURTUN			FILET	DIMENSIUNI (MM)			
	DN	INCH	DIAM	F	CH	B	A	L
202203.0314	5	3/16	03	M14X1.5	17	15	37	65
202203.0316	5	3/16	03	M16X1.5	19	15	37	65
202203.0414	6	1/4	04	M14X1.5	17	17	40	68
202203.0416	6	1/4	04	M16X1.5	19	17	50	78
202203.0418	6	1/4	04	M18X1.5	22	17	48.5	76
202203.0420	6	1/4	04	M20X1.5	24	17	48.5	76
202203.0518	8	5/16	05	M18X1.5	22	17	52.5	80
202203.0520	8	5/16	05	M20X1.5	24	20	50	78
202203.0618	10	3/8	06	M18X1.5	22	20	55	85
202203.0620	10	3/8	06	M20X1.5	24	17	57	86.5
202203.0622	10	3/8	06	M22X1.5	27	19	59	88.5
202203.0822	12	1/2	08	M22X1.5	27	22	65	98
202203.0824	12	1/2	08	M24X1.5	30	22	66.5	99
202203.1030	16	5/8	10	M30X2	36	26	64.5	100
202203.1230	19	3/4	12	M30X2	36	27	64	104.5
202203.1236	19	3/4	12	M36X2	46	28	70	110
202203.1636	25	1	16	M36X2	46	38	88.5	143
202203.1642	25	1	16	M42X2	50	38	89	144
202203.2042	32	1.1/4	20	M42X2	50	35	104.5	164.5
202203.2052	32	1.1/4	20	M52X2	60	35	104.5	164.5
202203.2452	40	1.1/2	24	M52X2	60	45	119	189



Straight standpipe

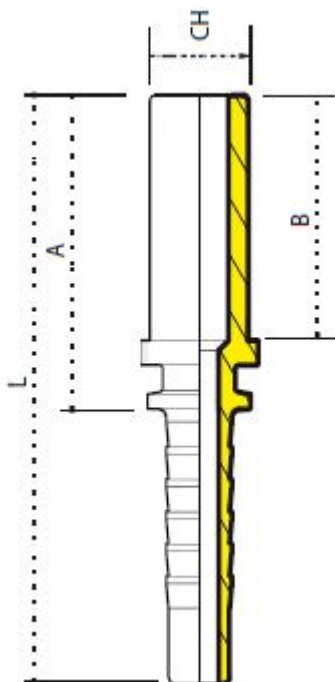

COD	FURTUN			FILET	DIMENSIUNI (MM)			
	DN	INCH	DIAM	F	CH	B	A	L
241002.0306	5	3/16	03	-	6	24	30	55
241002.0308	5	3/16	03	-	8	24	30	55
241002.0406	6	1/4	04	-	6	22.5	30.5	58.5
241002.0408	6	1/4	04	-	8	23	30.5	58.5
241002.0410	6	1/4	04	-	10	25	32	59.5
241002.0412	6	1/4	04	-	12	25	32	60
241002.0508	8	5/16	05	-	8	23	30	58
241002.0510	8	5/16	05	-	10	25	32	60
241002.0512	8	5/16	05	-	12	25	32	60
241002.0610	10	3/8	06	-	10	25.5	33	63
241002.0612	10	3/8	06	-	12	25	32.5	62
241002.0614	10	3/8	06	-	14	28	32.5	65.5
241002.0615	10	3/8	06	-	15	25.5	33	63
241002.0812	12	1/2	08	-	12	25	33	66
241002.0814	12	1/2	08	-	14	28	36	69
241002.0815	12	1/2	08	-	15	25.5	33.5	66.5
241002.0816	12	1/2	08	-	16	31	39	72
241002.0818	12	1/2	08	-	18	27	35.5	68.5
241002.1018	16	5/8	10	-	18	28	36	71.5
241002.1020	16	5/8	10	-	20	35	43.5	79.5
241002.1022	16	5/8	10	-	22	29	38	74
241002.1218	20	3/4	12	-	18	26	34.5	75
241002.1220	20	3/4	12	-	20	35	44	84.5
241002.1222	20	3/4	12	-	25	29.5	38	80
241002.1225	20	3/4	12	-	25	41	51	91.5
241002.1625	25	1	16	-	25	39.5	50	105
241002.1628	25	1	16	-	28	30.5	41	96
241002.1630	25	1	16	-	30	43.5	54	109
241002.2030	32	1.1/4	20	-	30	43	54.5	115
241002.2035	32	1.1/4	20	-	35	35.5	46.5	106.5
241002.2038	32	1.1/4	20	-	38	48	60	120
241002.2438	40	1.1/2	24	-	38	48	60	131
241002.2442	40	1.1/2	24	-	42	36	47	118



Double connector

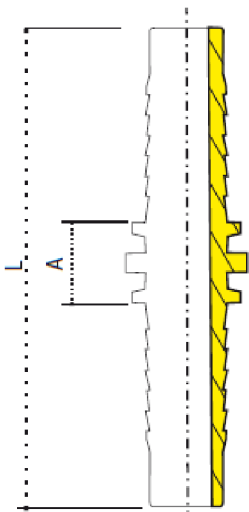

COD	FURTUN			FILET	DIMENSIUNI (MM)			
	DN	INCH	DIAM	F	CH	B	A	L
280300.04	6	1/4	04	-	-	-	14	70
280300.05	8	5/16	05	-	-	-	14	70
280300.06	10	3/8	06	-	-	-	15	75
280300.08	12	1/2	08	-	-	-	20	86
280300.10	16	5/8	10	-	-	-	16	88
280300.12	20	3/4	12	-	-	-	18	100
280300.16	25	1	16	-	-	-	20	130
280300.20	32	1.1/4	20	-	-	-	21	143

BSP banjo

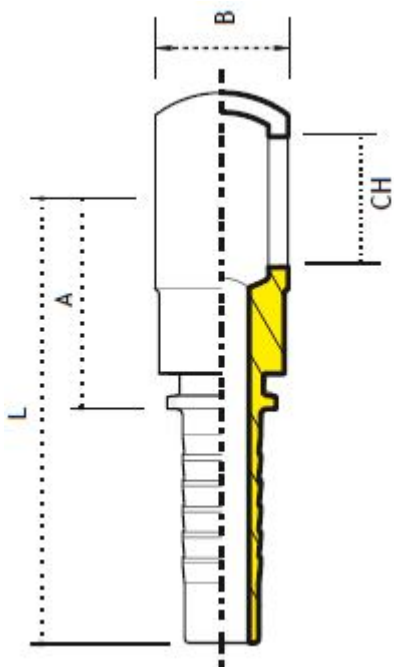

COD	FURTUN			FILET	DIMENSIUNI (MM)			
	DN	INCH	DIAM	F	CH	B	A	L
242800.0302	5	3/16	03	1/8"-28	10.0	10	19.5	45.0
242800.0304	5	3/16	03	1/4"-19	13.2	14	22.5	47.5
242800.0402	6	1/4	04	1/8"-28	10.0	10	24.0	52.0
242800.0404	6	1/4	04	1/4"-19	13.2	14	23.0	51.0
242800.0406	6	1/4	04	3/8"-19	16.7	17	26.5	54.5
242800.0408	6	1/4	04	1/2"-14	21.0	22	32.5	60.5
242800.0504	8	5/16	05	1/4"-19	13.2	14	24.0	52.0
242800.0506	8	5/16	05	3/8"-19	16.7	17	26.5	54.5
242800.0508	8	5/16	05	1/2"-14	21.0	22	27.5	61.0
242800.0604	10	3/8	06	1/4"-19	13.2	14	31.5	61.5
242800.0606	10	3/8	06	3/8"-19	16.7	17	26.5	56.5
242800.0608	10	3/8	06	1/2"-14	21.0	22	27.5	57.5
242800.0806	12	1/2	08	3/8"-19	16.7	17	31.0	64.0
242800.0808	12	1/2	08	1/2"-14	21.0	22	33.0	66.0
242800.0810	12	1/2	08	5/8"-14	23.3	25	32.5	65.5
242800.0812	12	1/2	08	3/4"-14	26.5	30	34.5	67.5
242800.1010	16	5/8	10	5/8"-14	23.3	25	32.5	68.5
242800.1012	16	5/8	10	3/4"-14	26.5	30	34.5	70.5
242800.1212	20	3/4	12	3/4"-14	26.5	30	35.0	76.0
242800.1216	20	3/4	12	1"-11	33.4	38	48.0	89.0
242800.1616	25	1	16	1"-11	33.4	38	43.0	98.0
242800.2020	32	1.1/4	20	1.1/4"-11	-	-	-	-



Metric banjo

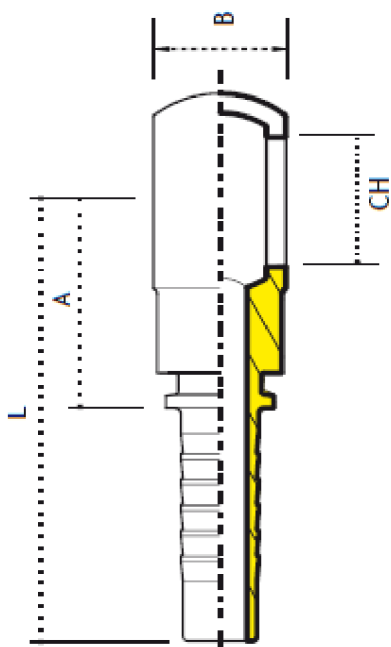

COD	FURTUN			FILET	DIMENSIUNI (MM)			
	DN	INCH	DIAM	F	CH	B	A	L
242010.0310	5	3/16	03	M10X1	10.1	10	20.0	45.0
242010.0312	5	3/16	03	M12X1.5	12.1	12	21.0	46.0
242010.0314	5	3/16	03	MX1.5	14.1	14	23.0	48.0
242010.0410	6	1/4	04	M10X1	10.1	10	24.0	52.0
242010.0412	6	1/4	04	M12X1.5	12.1	11	23.0	51.0
242010.0414	6	1/4	04	M14X1.5	14.1	14	23.0	51.0
242010.0416	6	1/4	04	M16X1.5	16.1	17	25.0	53.0
242010.0418	6	1/4	04	M18X1.5	18.1	20	29.0	57.0
242010.0512	8	5/16	05	M12X1.5	12.1	12	2.0	52.0
242010.0514	8	5/16	05	M14X1.5	14.1	14	24.5	52.5
242010.0516	8	5/16	05	M16X1.5	16.1	17	27.0	55.0
242010.0518	8	5/16	05	M18X1.5	18.1	20	29.0	57.0
242010.0520	8	5/16	05	M20X1.5	20.1	22	28.0	56.0
242010.0522	8	5/16	05	M22X1.5	22.1	22	28.0	56.0
242010.0614	10	3/8	06	M14X1.5	14.1	14	27.0	57.0
242010.0616	10	3/8	06	M16X1.5	16.1	17	27.0	57.0
242010.0618	10	3/8	06	M18X1.5	18.1	20	28.0	58.0
242010.0620	10	3/8	06	M36X1.5	20.1	22	28.5	58.5
242010.0622	10	3/8	06	M20X1.5	22.1	22	28.5	58.5
242010.0818	12	1/2	08	M22X1.5	18.1	20	30.0	63.0
242010.0820	12	1/2	08	M18X1.5	20.1	22	34.0	67.0
242010.0822	12	1/2	08	M20X1.5	22.1	22	34.0	67.0
242010.0826	12	1/2	08	M26X1.5	-	-	-	-
242010.1022	16	5/8	10	M22X1.5	22.1	22	34	70
242010.1026	16	5/8	10	M26X1.5	-	-	-	-
242010.1226	20	3/4	12	M26X1.5	-	-	-	-
242010.1230	20	3/4	12	M30X1	30.1	36	41.5	82.5
242010.1630	25	1	16	M30X1.5	30.1	36	41.5	96.5



FLANGE SAE 3000 PSI

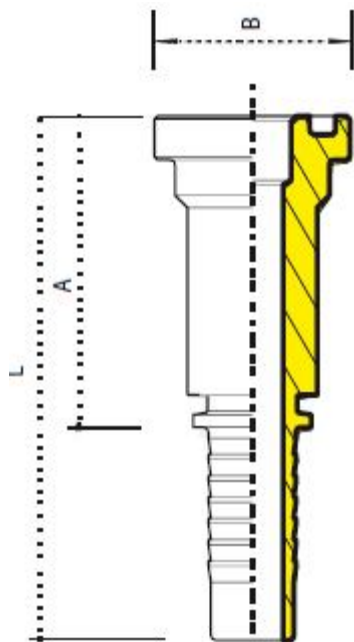

COD	FURTUN			FILET	DIMENSIUNI (MM)			
	DN	INCH	DIAM	F	CH	B	A	L
223100.0808	12	1/2	08	1/2"	-	30.2	49	82
223100.0810	12	1/2	08	5/8"	-	34.0	49	81
223100.0812	12	1/2	08	3/4"	-	38.1	52	84
223100.1008	16	5/8	10	1/2"	-	30.2	49	85
223100.1010	16	5/8	10	5/8"	-	34.0	49	85
223100.1012	16	5/8	10	3/4"	-	38.1	48	84
223100.1208	20	3/4	12	1/2"	-	30.2	47	88
223100.1212	20	3/4	12	3/4"	-	38.1	47	88
223100.1216	20	3/4	12	1"	-	44.5	50	91
223100.1612	25	1	16	3/4"	-	38.1	50	91
223100.1616	25	1	16	1"	-	44.5	50	105
223100.1620	25	1	16	1.1/4"	-	50.8	67	120
223100.2016	32	1.1/4	20	1"	-	44.5	57	117
223100.2020	32	1.1/4	20	1.1/4"	-	50.8	65	125
223100.2024	32	1.1/4	20	1.1/2"	-	60.3	70	130
223100.2424	40	1.1/2	24	1.1/2"	-	60.3	70	141
223100.2432	40	1.1/2	24	2"	-	71.4	72	143
223100.3232	50	2	32	2"	-	71.4	73	153

90 FLANGE SAE 3000 PSI

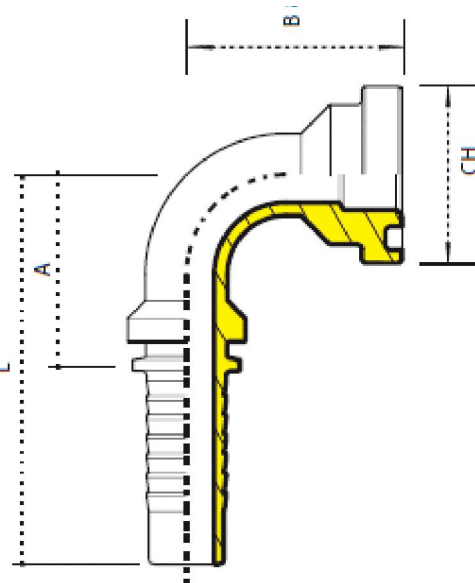

COD	FURTUN			FILET	DIMENSIUNI (MM)			
	DN	INCH	DIAM	F	CH	B	A	L
223900.0808	12	1/2	08	1/2"	30.2	43	39	72
223900.0812	12	1/2	08	3/4"	38.1	50	39	72
223900.1008	16	5/8	10	1/2"	30.2	49	49	85
223900.1012	16	5/8	10	3/4"	38.1	55	49	85
223900.1208	20	3/4	12	1/2"	30.2	52	57	98
223900.1212	20	3/4	12	3/4"	38.1	58	57	98
223900.1216	25	1	16	1"	44.5	62	57	98
223900.1612	25	1	16	3/4"	38.1	60	77	132
223900.1616	25	1	16	1"	44.5	64	77	132
223900.1620	25	1	16	1.1/4"	50.8	70	77	132
223900.2016	32	1.1/4	20	1"	44.5	82	89	150
223900.2020	32	1.1/4	20	1.1/4"	50.8	87	89	150
223900.2024	32	1.1/4	20	1.1/2"	60.3	88	89	150
223900.2424	40	1.1/2	24	1.1/2"	60.3	102	101	172
223900.2432	40	1.1/2	24	2"	71.4	118	101	172
223900.3232	50	2	32	2"	71.4	120	144	224



45 FLANGE SAE 3000 PSI

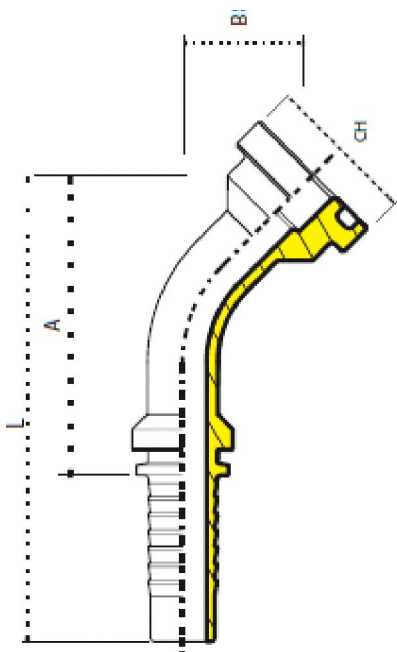

COD	FURTUN			FILET	DIMENSIUNI (MM)			
	DN	INCH	DIAM	F	CH	B	A	L
223400.0808	12	1/2	08	1/2"	30.2	23	63	96
223400.0812	12	1/2	08	3/4"	38.1	28	68	101
223400.1008	16	5/8	10	1/2"	30.2	26	59	95
223400.1012	16	5/8	10	3/4"	38.1	30	63	99
223400.1208	20	3/4	12	1/2"	30.2	28	63	104
223400.1212	20	3/4	12	3/4"	38.1	32	67	108
223400.1216	25	1	16	1"	44.5	35	70	111
223400.1612	25	1	16	3/4"	38.1	35	83	138
223400.1616	25	1	16	1"	44.5	32	86	141
223400.1620	25	1	16	1.1/4"	50.8	36	90	145
223400.2016	32	1.1/4	20	1"	44.5	36	96	157
223400.2020	32	1.1/4	20	1.1/4"	50.8	43	100	161
223400.2024	32	1.1/4	20	1.1/2"	60.3	44	101	162
223400.2424	40	1.1/2	24	1.1/2"	60.3	41	112	183
223400.2432	40	1.1/2	24	2"	71.4	52	123	194
223400.3232	50	2	32	2"	71.4	59	148	228

FLANGE SAE 6000 PSI

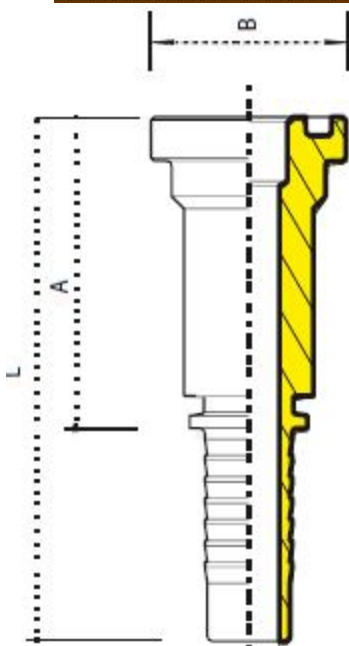

COD	FURTUN			FILET	DIMENSIUNI (MM)			
	DN	INCH	DIAM	F	CH	B	A	L
226100.0808	12	1/2	08	1/2"	-	31.7	50	83
226100.0812	12	1/2	08	3/4"	-	41.3	55	87
226100.1008	16	5/8	10	1/2"	-	31.7	50	86
226100.1012	16	5/8	10	3/4"	-	41.3	51	87
226100.1208	20	3/4	12	1/2"	-	31.7	53	94
226100.1212	20	3/4	12	3/4"	-	41.3	53	94
226100.1216	25	1	16	1"	-	47.6	64	105
226100.1612	25	1	16	3/4"	-	41.3	64	105
226100.1616	25	1	16	1"	-	47.6	66	121
226100.1620	25	1	16	1.1/4"	-	54.0	71	126
226100.2016	32	1.1/4	20	1"	-	47.6	66	126
226100.2020	32	1.1/4	20	1.1/4"	-	54.0	67	127
226100.2024	32	1.1/4	20	1.1/2"	-	63.5	78	139
226100.2424	40	1.1/2	24	1.1/2"	-	63.5	78	149
226100.2432	40	1.1/2	24	2"	-	79.4	73	143
226100.3232	50	2	32	2"	-	79.4	73	153



90 FLANGE SAE 6000 PSI

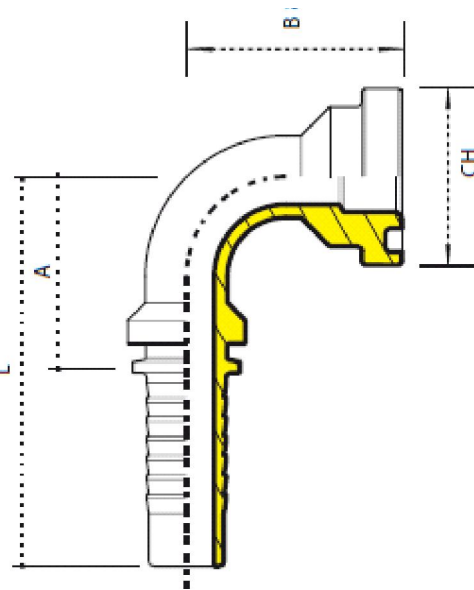

COD	FURTUN			FILET	DIMENSIUNI (MM)			
	DN	INCH	DIAM	F	CH	B	A	L
226900.0808	12	1/2	08	1/2"	31.7	43	39	72
226900.0812	12	1/2	08	3/4"	41.3	50	39	72
226900.1008	16	5/8	10	1/2"	31.7	49	49	85
226900.1012	16	5/8	10	3/4"	41.3	55	49	85
226900.1208	20	3/4	12	1/2"	31.7	52	57	98
226900.1212	20	3/4	12	3/4"	41.3	58	57	98
226900.1612	25	1	16	3/4"	41.3	60	77	132
226900.1616	25	1	16	1"	47.6	64	77	132
226900.1620	25	1	16	1.1/4"	54.0	70	77	132
226900.2016	32	1.1/4	20	1"	47.6	82	89	150
226900.2020	32	1.1/4	20	1.1/4"	54.0	87	89	150
226900.2024	32	1.1/4	20	1.1/2"	63.5	88	89	150
226900.2424	40	1.1/2	24	1.1/2"	63.5	102	101	172
226900.2432	40	1.1/2	24	2"	79.4	118	101	172
226900.3232	50	2	32	2"	79.4	120	144	224

45 FLANGE SAE 6000 PSI

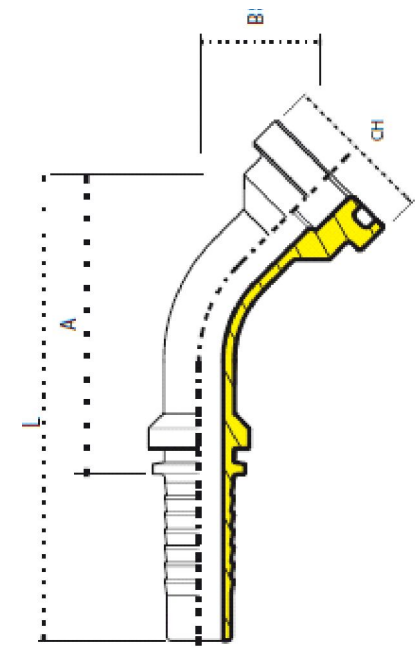

COD	FURTUN			FILET	DIMENSIUNI (MM)			
	DN	INCH	DIAM	F	CH	B	A	L
226400.0808	12	1/2	08	1/2"	31.7	23	64	97
226400.0812	12	1/2	08	3/4"	41.3	28	69	102
226400.1008	16	5/8	10	1/2"	31.7	26	60	96
226400.1012	16	5/8	10	3/4"	41.3	30	66	102
226400.1208	20	3/4	12	1/2"	31.7	28	64	105
226400.1212	20	3/4	12	3/4"	41.3	32	70	111
226400.1216	20	3/4	12	1"	47.6	35	74	115
226400.1612	25	1	16	3/4"	41.3	35	86	141
226400.1616	25	1	16	1"	47.6	32	89	144
226400.1620	25	1	16	1.1/4"	54.0	36	94	149
226400.2016	32	1.1/4	20	1"	47.6	36	100	161
226400.2020	32	1.1/4	20	1.1/4"	54.0	43	104	165
226400.2024	32	1.1/4	20	1.1/2"	63.5	44	107	168
226400.2424	40	1.1/2	24	1.1/2"	63.5	41	118	189
226400.2432	40	1.1/2	24	2"	79.4	52	119	190
226400.3232	50	2	32	2"	79.4	59	153	233



FLANGE SUPERCAT

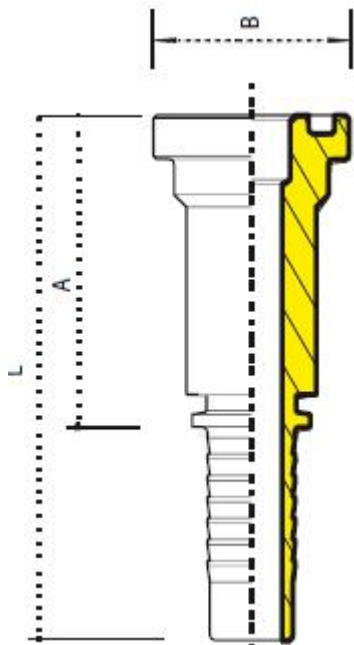

COD	FURTUN			FILET	DIMENSIUNI (MM)			
	DN	INCH	DIAM	F	CH	B	A	L
227100.1212	20	3/4	12	3/4"	-	41.3	58	99
227100.1216	20	3/4	12	1"	-	47.6	70	111
227100.1616	25	1	16	1"	-	47.6	72	127
227100.1620	25	1	16	1.1/4"	-	54.0	75	130
227100.2020	32	1.1/4	20	1.1/4"	-	54.0	71	131
227100.2024	32	1.1/4	20	1.1/2"	-	63.5	80	141
227100.2424	40	1.1/2	24	1.1/2"	-	63.5	80	151

FLANGE SUPERCAT 90

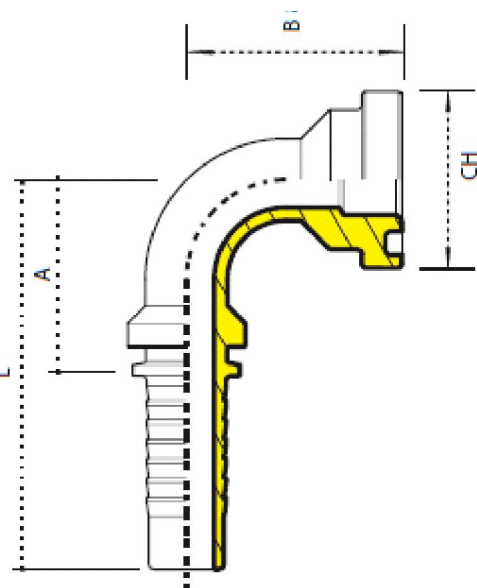

COD	FURTUN			FILET	DIMENSIUNI (MM)			
	DN	INCH	DIAM	F	CH	B	A	L
227900.1212	20	3/4	12	3/4"	41.3	67	57	98
227900.1216	20	3/4	12	1"	47.6	73	57	98
227900.1616	25	1	16	1"	47.6	75	77	132
227900.1620	25	1	16	1.1/4"	54.0	80	77	132
227900.2020	32	1.1/4	20	1.1/4"	54.0	97	89	150
227900.2024	32	1.1/4	20	1.1/2"	63.5	99	89	150
227900.2424	40	1.1/2	24	1.1/2"	63.5	113	101	172





FLANGE SUPERCAT 45

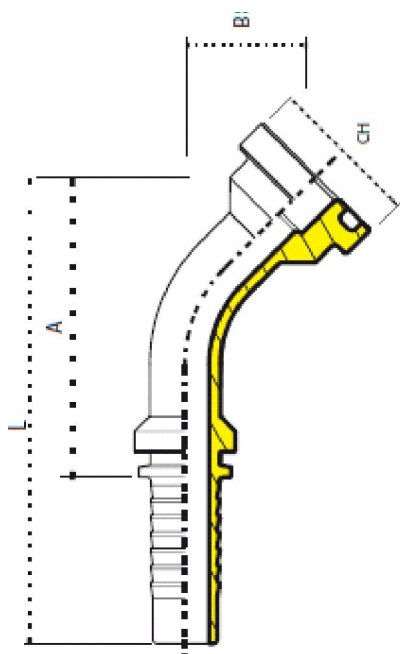

COD	FURTUN			FILET	DIMENSIUNI (MM)			
	DN	INCH	DIAM	F	CH	B	A	L
227400.1212	20	3/4	12	3/4"	41.3	39	74	115
227400.1216	20	3/4	12	1"	47.6	43	78	119
227400.1616	25	1	16	1"	47.6	40	94	149
227400.1620	25	1	16	1.1/4"	54.0	43	97	152
227400.2020	32	1.1/4	20	1.1/4"	54.0	50	107	168
227400.2024	32	1.1/4	20	1.1/2"	63.5	51	108	169
227400.2424	40	1.1/2	24	1.1/2"	63.5	49	120	191



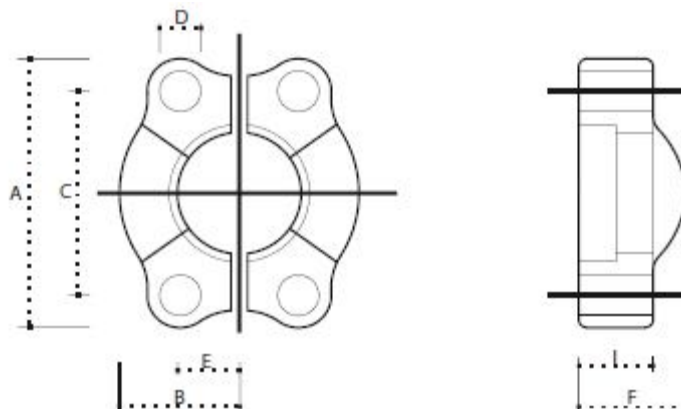

Split flange clamps couple SAE 3000

COD	FURTUN			FILET	DIMENSIUNI (MM)						
	DN	INCH	DIAM	F	A	B	C	D	E	F	I
222100.0808	12	1/2	08	1/2"	56.3	23.8	40.5	9	9.2	15.9	22.2
222100.1212	20	3/4	12	3/4"	71.4	30.2	50.8	11	11.9	19.0	28.6
222100.1616	25	1	16	1"	80.9	34.9	57.1	13	13.9	22.2	36.5
222100.2020	32	1.1/4	20	1.1/4"	95.2	38.9	66.7	15	15.8	23.8	39.7
222100.2024	32	1.1/4	20	1.1/2"	112.7	47.6	79.4	17	18.2	27.0	46
222100.2424	40	1.1/2	24	1.1/2"	113.3	57.1	96.8	21	22.2	36.5	55.6

Split flange clamps couple SAE 6000

COD	FURTUN			FILET	DIMENSIUNI (MM)						
	DN	INCH	DIAM	F	A	B	C	D	E	F	I
222200.0808	12	1/2	08	1/2"	56.3	23.8	40.5	9	9.2	15.9	22.2
222200.1212	20	3/4	12	3/4"	71.4	30.2	50.8	11	11.9	19.0	28.6
222200.1616	25	1	16	1"	80.9	34.9	57.1	13	13.9	22.2	36.5
222200.2020	32	1.1/4	20	1.1/4"	95.2	38.9	66.7	15	15.8	23.8	39.7
222200.2424	40	1.1/2	24	1.1/2"	112.7	47.6	79.4	17	18.2	27.0	46.0
222200.3232	50	2	32	2"	113.3	57.1	96.8	21	22.2	36.5	55.6

